

ALL
ET
TI

4

LINEGiANSER

Bènvegnù a 'sto mund de confort e stìl avanguardista. Sem cuntent de presenta ul nostr neuf catalogh de letc, 'na scelta de pezz che s'abrascia al design modèrn e l'innovaçion pèr fa sì che 'la tua stanza da letc sia 'na cà d'or, 'na curt de 'legansa contemporanea.

Benvenuti nel mondo del comfort e dello stile all'avanguardia. Siamo entusiasti di presentarvi il nostro nuovo catalogo di letti, una selezione di pezzi che abbracciano il design moderno e l'innovazione per trasformare la tua camera da letto in uno spazio di eleganza contemporanea.

Welcome to the world of cutting-edge comfort and style. We are excited to present our new catalog of beds, a selection of pieces that embrace modern design and innovation to transform your bedroom into a space of contemporary elegance.

Bienvenidos al mundo del confort y el estilo de vanguardia. Nos complace presentar nuestro nuevo catálogo de camas, una selección de piezas que abrazan el diseño moderno y la innovación para transformar tu dormitorio en un espacio de elegancia contemporánea.

Bienvenue dans le monde du confort et du style avant-gardiste. Nous sommes ravis de vous présenter notre nouveau catalogue de lits, une sélection de pièces qui embrassent le design moderne et l'innovation pour transformer votre chambre en un espace d'élégance contemporaine.

Willkommen in der Welt von Komfort und avantgardistischem Stil. Wir freuen uns, Ihnen unseren neuen Katalog von Betten vorzustellen, eine Auswahl von Stücken, die modernes Design und Innovation umarmen, um Ihr Schlafzimmer in einen Raum zeitgenössischer Eleganz zu verwandeln.

Добро пожаловать в мир передового комфорта и стиля. Мы с удовольствием представляем вам наш новый каталог кроватей, подборку изделий, которые объединяют в себе современный дизайн и инновации для того, чтобы превратить вашу спальню в пространство современной элегантности.

☑欢迎来到舒适和前☑☑格的世界。我☑很高兴向您介☑我☑的新床上用品目☑, ☑是一系列☑抱☑代☑☑和☑新的精☑款, 旨在将您的卧室打造一个充☑当代☑雅的空☑。

INDICE

WIND RITMUS	pag. 004
GIRO	pag. 018
AURORA	pag. 032
QUINTA VERTICALE	pag. 046
STEFANO	pag. 060
WIND BASIC	pag. 074
GIRO	pag. 088
JASMINE	pag. 102
WIND SPLIT	pag. 116
QUINTA	pag. 130
JASMINE LEGNO	pag. 144
SELENE	pag. 158
WIND RITMUS	pag. 172
GABBIANO	pag. 186
VALENTINA	pag. 200
JASMINE KING	pag. 214
AMBRA	pag. 228
VELA	pag. 242
INSIDE	pag. 256

WIND RITMUS

il richiamo della natura
the call of nature







Qui e nelle pagine precedenti: letto Wind nella versione ritmus sospesa, testata in legno con pannelli in rovere bruciato con la preziosa lavorazione cannetè. Letto con cassonetto contenitore rientrante sospeso, fascia giroletto in essenza e contenitore laccato canna di fucile opaco. Comodini della serie Wind sospesi con struttura e mensole a croce laccati mastice. Testata con cuscino sfoderabile rivestito in microfibra.

Here and on the previous pages: Wind bed in the suspended Ritmus version, wooden headboard with panels in burned oak featuring the precious "cannetè" processing. Bed with a suspended recessed storage box, bed frame border in oak wood, and storage box lacquered in matte gunmetal gray. Suspended bedside tables from the Wind series with a structure, fronts, and cross-shaped shelves lacquered in mastice. Headboard with a removable cushion covered in microfiber.

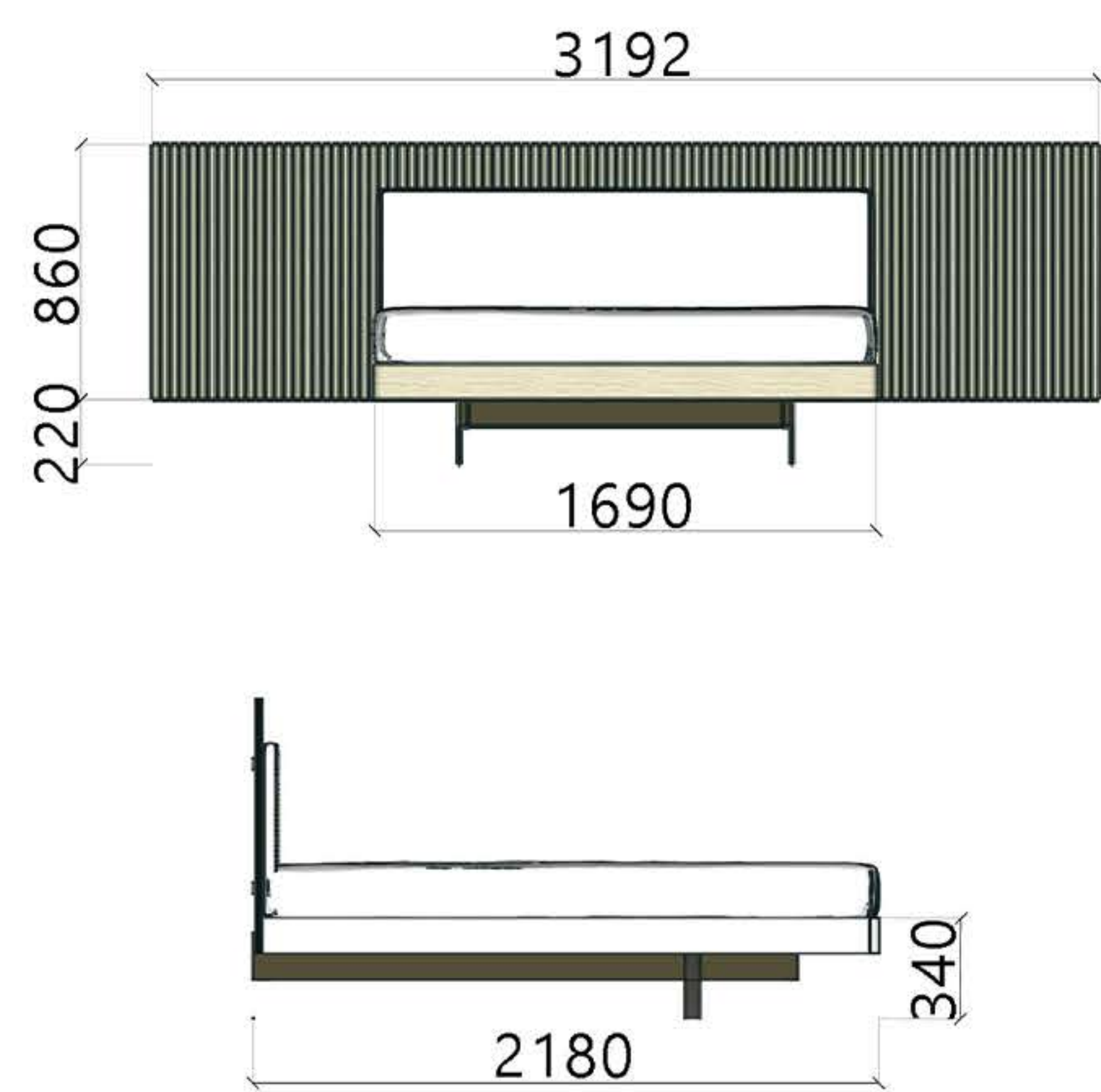



Integrated closet area with hanging clothes, a mirror, and a chest of drawers.



Open shelving unit containing books, decorative objects, and a small sculpture.



Qui e nelle pagine precedenti armadio a battente della collezione "Tutte le Notti" con ante lisce Basic laccate verde oliva. Maniglie a tutt'altezza laccata dello stesso colore nelle ante Level. Armadiatura con vano beauty, passaggio a locale adiacente, elemento angolare e terminale a libreria.

Here and on the previous pages: swing door wardrobe from the "Tutte le Notti" collection with smooth Basic doors lacquered in olive green. Full-height handles lacquered in the same color on the Level doors. The wardrobe includes a beauty compartment, passage to an adjacent room, corner element, and end unit for a library.





Toeletta a 1 cassetto e vano porta oggetti con specchio della serie Aurora con struttura e frontali mastiche.
Sedia Artù con gambe in rovere bruciato e sedutarivestita in microfibra.

Dressing table with 1 drawer and a compartment for objects with a mirror from the Aurora series, featuring a structure and fronts in mastic. Artù chair with legs in burned oak and a seat covered in microfiber.





"Il Richiamo della Natura: Un'Armonia di Design e Serenità"

Benvenuti in una collezione dove la natura ispira il design e la tranquillità. "Il Richiamo della Natura" è un invito a immergersi in un mondo di armonia, dove elementi naturali si fondono con un'estetica moderna. Ogni pezzo racconta una storia di connessione con il mondo naturale, portando l'energia rigenerante della natura nella tua stanza. Scoprite come il richiamo della natura può trasformare il vostro spazio notturno in un rifugio sereno di comfort e bellezza senza tempo. Lasciatevi avvolgere dalla calda accoglienza di "Il Richiamo della Natura".

"The Call of Nature: Harmony of Design and Serenity"

Welcome to a collection where nature inspires design and tranquility. "The Call of Nature" is an invitation to immerse yourself in a world of harmony, where natural elements merge with modern aesthetics. Each piece tells a story of connection with the natural world, bringing the rejuvenating energy of nature into your room. Discover how the call of nature can transform your nighttime space into a serene haven of comfort and timeless beauty. Let yourself be enveloped by the warm embrace of "The Call of Nature."



GIROLETTO

stile essenziale
essential style







Qui e nelle pagine precedenti: letto Giro con cassonetto contenitore rientrante, fascia giroletto in rovere carbone e contenitore laccato grafite opaco. La testata è formata da bussolotti con anta battente della serie Orizzonte laccati grafite opaco per avere un'ampia capacità contenitiva. Nel vano portaoggetti sopra la testata la schiena è rivestita in gres porcellanato color tafu. Completa la proposta di arredo la pannellatura ritmus retroilluminata. Per non ostacolare l'apertura della testata i comodini sono sostituiti con comodi pouf cilindrici e con tavolini Tulip con piano in rovere carbone.

Here and on the previous pages: Giro bed with a recessed storage box, bed frame border in charcoal oak, and storage box lacquered in matte graphite. The headboard is formed by wall cabinets with hinged doors from the Orizzonte series, lacquered in matte graphite for ample storage capacity. In the compartment above the headboard, the back is covered in porcelain stoneware in the tafu color. Completing the furniture proposal is the backlit Ritmus paneling. To avoid obstructing the headboard's opening, the bedside tables are replaced with convenient cylindrical poufs and Tulip tables with a charcoal oak top.

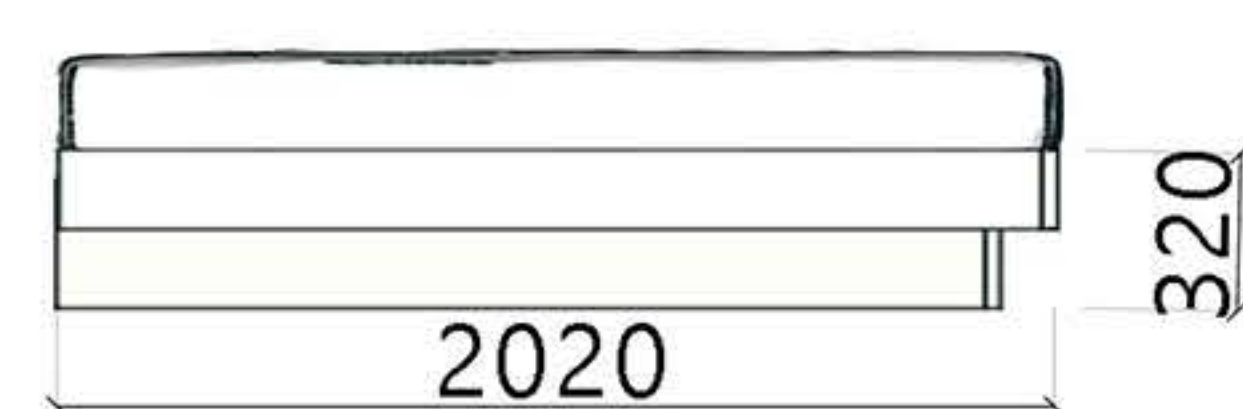
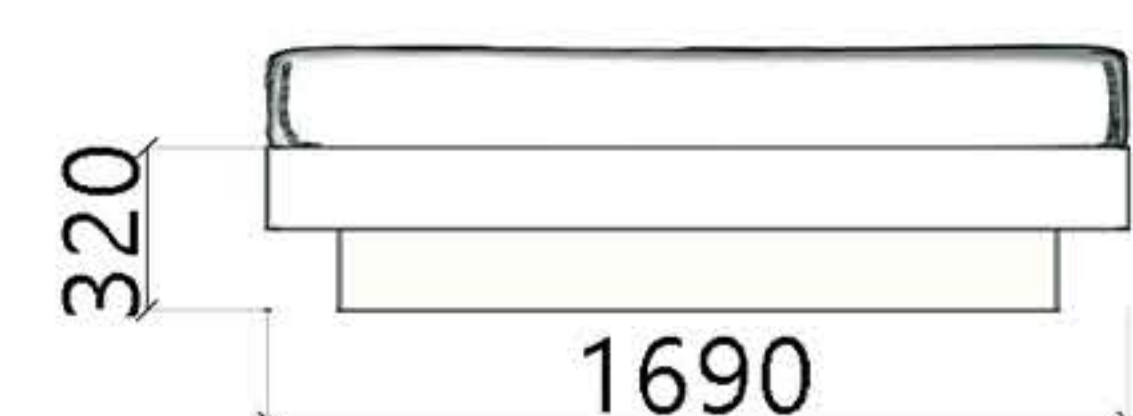



Dettaglio maniglia per ante Ritmus.

The detail of the handle for Ritmus doors.

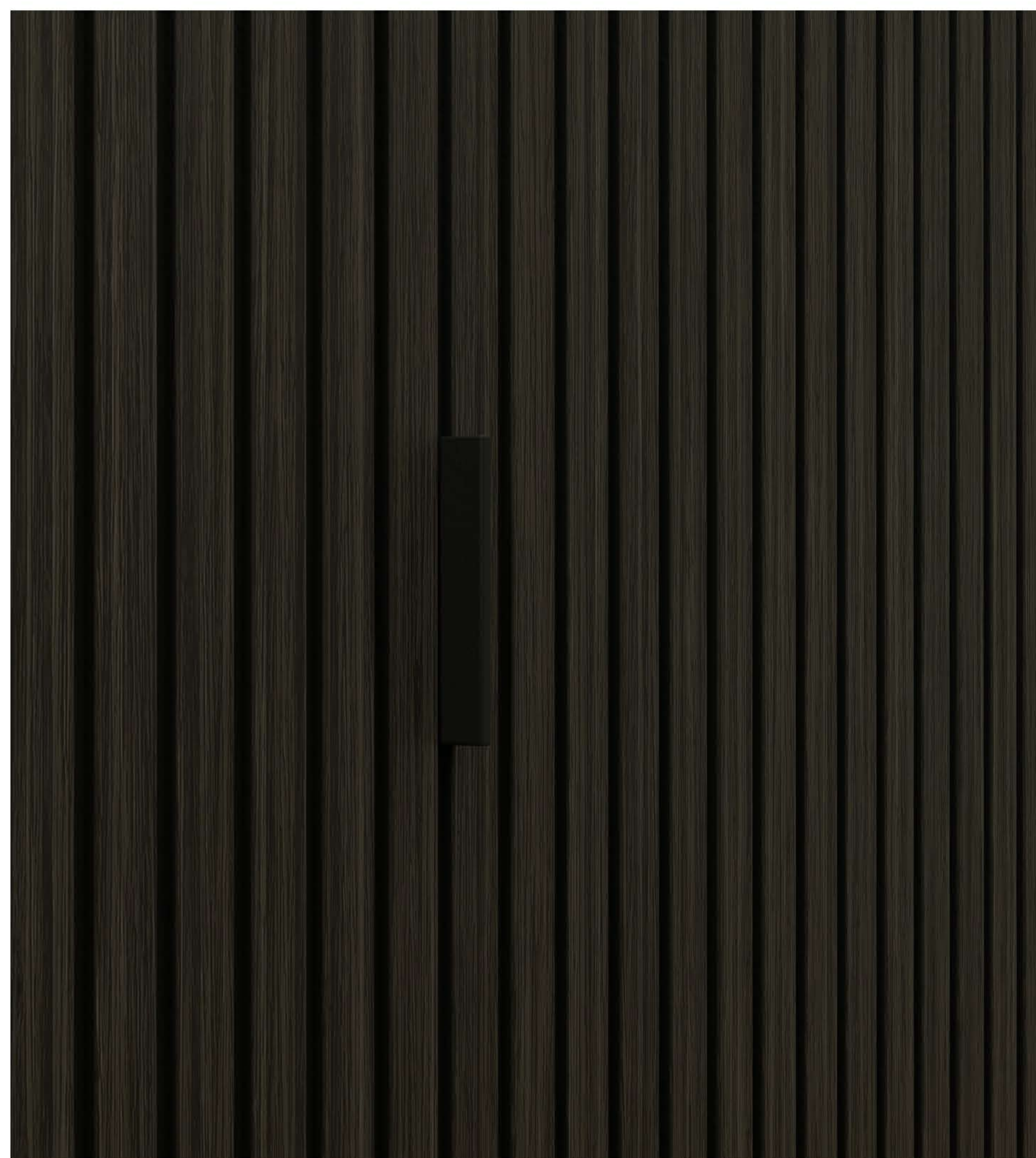

Qui e nelle pagine precedenti armadio a battente della collezione " Tutte le Notti" con ante Plumb e ante cannettate Ritmus in rovere carbone. Integrata una porta nella stessa finitura per accedere a un altro locale.

Here and on the previous pages: swing door wardrobe from the "Tutte le Notti" collection with Plumb doors and Ritmus doors with canneté detailing, all in charcoal oak. Integrated into the wardrobe is a door in the same finish to access another room.





Madia sospesa della serie "Aurora" struttura e top superiore laccato ferro opaco, frontali in gres porcellanato color tafu. Apertura per ante e cassetti con sistema push-pull.

Suspended sideboard from the "Aurora" series, structure and upper top lacquered in matte iron, front panels in porcelain stoneware in the tafu color. Opening for doors and drawers with a push-pull system.





"Stile Essenziale: Eleva il Tuo Spazio Notturmo con Semplicità e Raffinatezza"

Benvenuti in una collezione dove l'essenza del design si manifesta nell'eleganza senza tempo. "Stile Essenziale" è il mantra che guida ogni pezzo della nostra selezione di letti e gruppi notte. Linee pulite, forme essenziali e dettagli raffinati convergono per creare un ambiente notturno che celebra la bellezza della semplicità. Scoprite come l'armonia del design minimalista può trasformare la vostra stanza in uno spazio di tranquillità e stile distintivo. Lasciatevi avvolgere dalla chiarezza di "Stile Essenziale".



"Essential Style: Elevate Your Nighttime Space with Simplicity and Sophistication"

Welcome to a collection where the essence of design manifests in timeless elegance. "Essential Style" is the mantra that guides every piece in our selection of beds and bedroom sets. Clean lines, essential forms, and refined details converge to create a nighttime environment that celebrates the beauty of simplicity. Discover how the harmony of minimalist design can transform your room into a space of tranquility and distinctive style. Let yourself be enveloped by the clarity of "Essential Style."

AURORA

futuro elegante
elegant future







Qui e nelle pagine precedenti: letto Aurora, testata in legno con pannello centrale in rovere sahara e pannelli laterali laccati fango opaco. Letto con cassonetto contenitore rientrante, fascia giroletto in rovere sahara e contenitore laccato fango opaco. Comodini della serie Aurora con struttura laccata fango opaco e frontali in rovere sahara. Settimanali a 5 cassetti e 1 cassettone della serie Aurora con struttura laccata fango opaco e frontali in rovere sahara. Specchiera rotonda Frame con fascia laccata argilla e tavolino Trip con piano laccato argilla e base bronzo.

Here and in the previous pages: bed Aurora, wooden headboard with central panel in sahara oak and side panels lacquered in matte mud. Bed with recessed storage box, bed frame in sahara oak, and storage box lacquered in matte mud. Bedside tables from the Aurora series with a matte mud lacquered structure and front panels in sahara oak. Tallboys with 5 drawers and 1 chest of drawers from the Aurora series with a matte mud lacquered structure and front panels in Sahara oak. Round mirror Frame with a clay lacquered trim and Trip table with a clay lacquered top and bronze base.

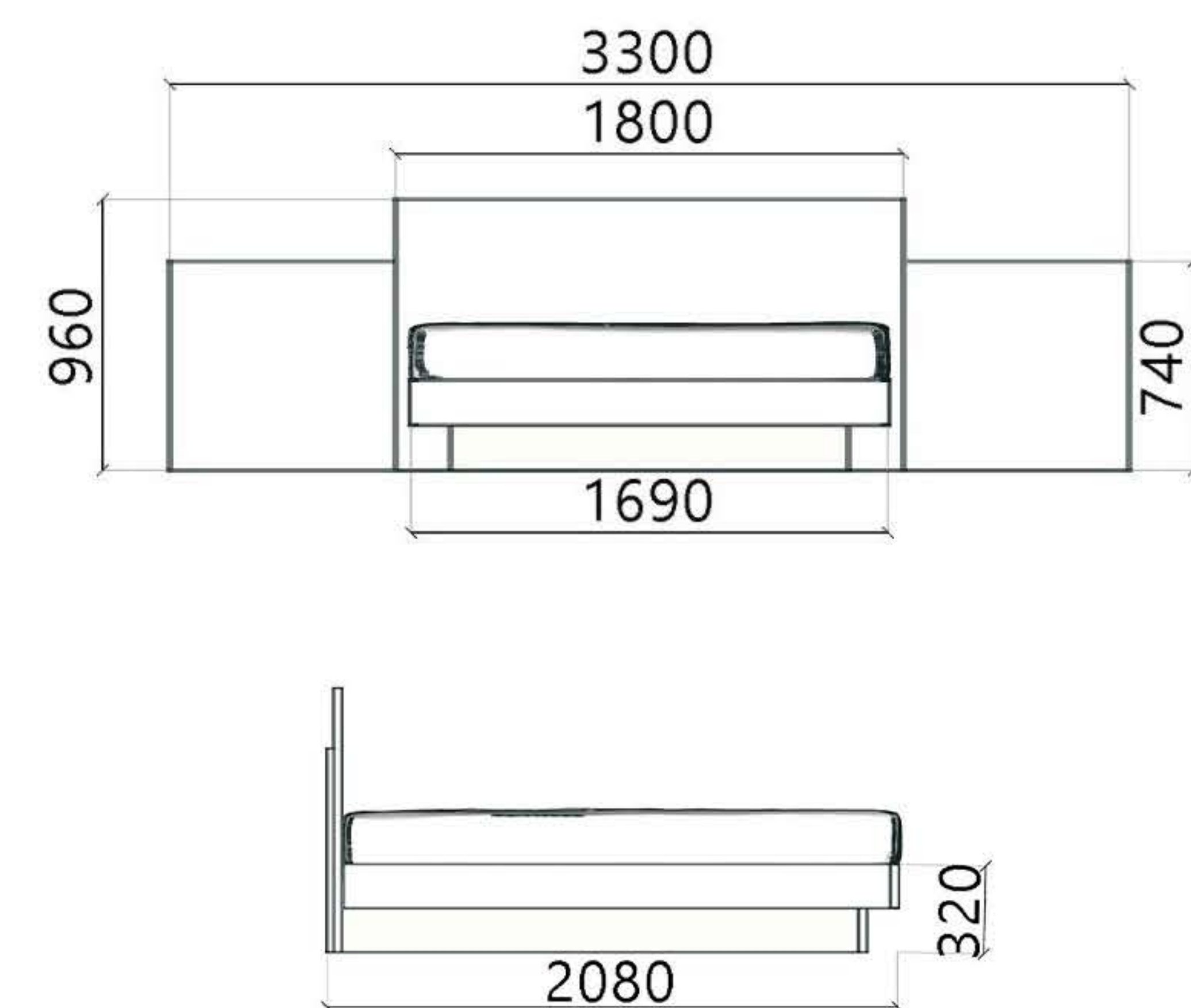



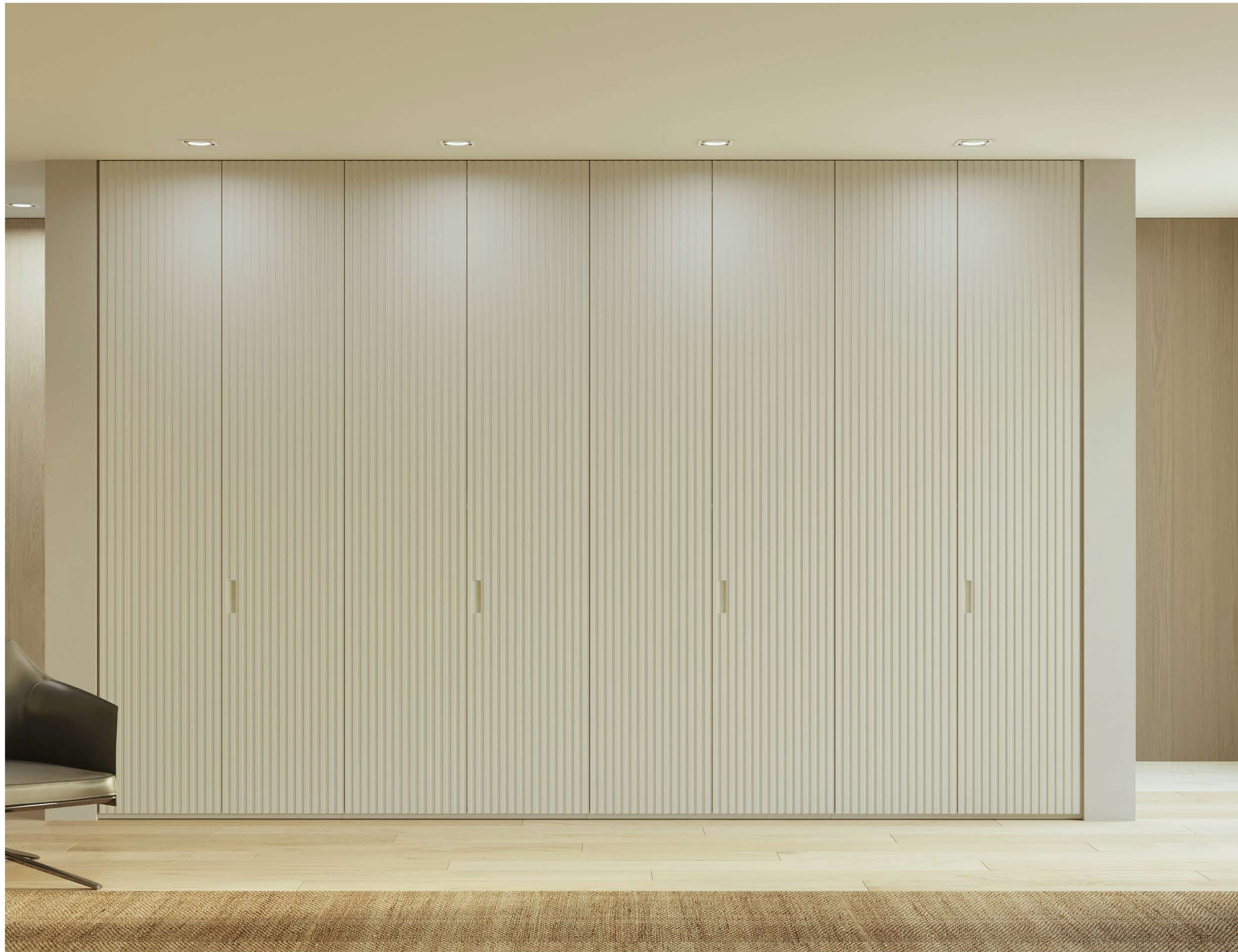

Qui e nelle pagine precedenti armadio a battente della collezione " Tutte le Notti" con ante plissettate Onda laccate sabbia opaco.
Particolare della maniglia incavata con stessa finitura.

*Here and on the previous pages, a hinged doors wardrobe from the "Tutte le Notti" collection with pleated Onda doors lacquered in matte sand.
Special detail on the recessed handle with the same finish.*



Tavolino Trip con piano laccato argilla e base bronzo.

Trip table with a clay lacquered top and bronze base.



Settimanali a 5 cassetti e 1 cassettone della serie Aurora con struttura laccata fango opaco e frontali in rovere sahara.
Specchiera rotonda Frame con fascia laccata argilla.

Tallboys with 5 drawers and 1 chest of drawers from the Aurora series with a matte mud lacquered structure and front panels in Sahara oak. Round mirror Frame with a clay lacquered trim.





"Futuro Elegante: Un'Anteprima di Design Raffinato"

Benvenuti in una visione avveniristica dove il design incontra l'eleganza. "Futuro Elegante" è una collezione che prefigura lo stile di domani, offrendo un'anteprima di ciò che il design sofisticato può offrire. Ogni pezzo è una dichiarazione di modernità senza tempo, con linee pulite e dettagli raffinati che definiscono il concetto di eleganza futuristica. Scoprite come questa collezione trasforma la vostra camera da letto in uno spazio di lusso e stile all'avanguardia. Lasciate che "Futuro Elegante" sia la vostra guida nella prossima era del design.

"Elegant Future: A Preview of Refined Design"

Welcome to a futuristic vision where design meets elegance. "Elegant Future" is a collection that foreshadows the style of tomorrow, offering a preview of what sophisticated design can deliver. Each piece is a statement of timeless modernity, with clean lines and refined details defining the concept of futuristic elegance. Discover how this collection transforms your bedroom into a space of luxury and cutting-edge style. Let "Elegant Future" be your guide into the next era of design.



QUINTA VERTICALE

minimalismo chich
chic minimalism







Qui e nelle pagine precedenti: letto Quinta nella versione verticale, testata in legno con pannello avanzato laccati ghiaia opaco e pannello posteriore ritmus dallo sviluppo verticale in rovere bruciato. Letto con piedi metallici a filo e fascia giroletto in rovere bruciato. Comodini della serie Noah a 1 cassetto con struttura e facciate laccate terra di Siena appoggiato su base metallica.

Here and on the previous pages: Quinta bed in the vertical version, wooden headboard with extended matte gravel lacquered panel and a Ritmus vertical development burned oak back panel. Bed with flush metallic feet and a bed frame border in burned oak. Noah bedside tables with 1 drawer, featuring a structure and fronts lacquered in terra di Siena, resting on a metallic base.

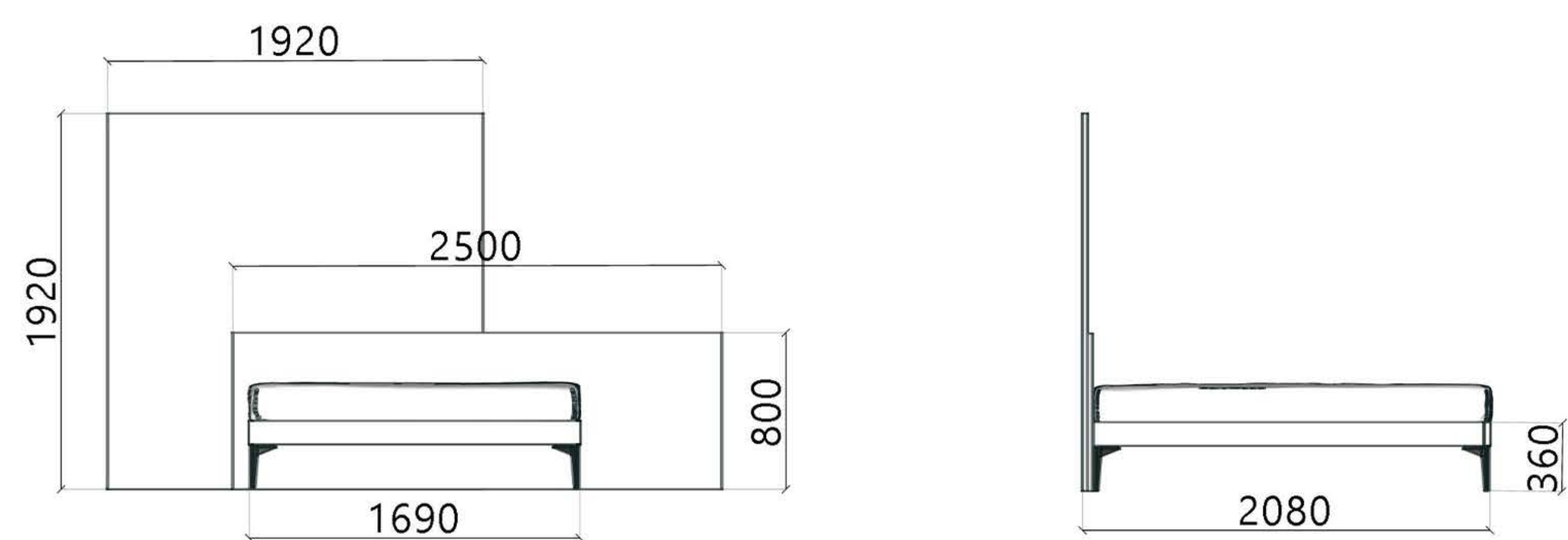





Qui e nelle pagine precedenti divisorio centrostanza Orizzonte-evo.
Spallette metalliche e schienale in vetro il tutto assemblato a
incastro con notevole rigidità strutturale.

*Here and on the previous pages Center-room divider Orizzonte-evo.
Metal side panels and glass back, all assembled with interlocking pieces
with significant structural rigidity.*





In queste pagine cabina armadio beta della collezione "Tutte le Notti" montanti di struttura in alluminio color canna di fucile elementi orizzontali e schienali laccati ghiaia opaco. Chiusura della stanza con ante scorrevoli laccate ghiaia opaco complete di sagome uso maniglia, binario di scorrimento incassato a soffitto.

On these pages, Beta walk-in closet from the "Tutte le Notti" collection. Structure uprights in gunmetal aluminum, horizontal elements, and back panels lacquered in matte gravel. Room closure with sliding doors lacquered in matte gravel, complete with handle-shaped outlines, and a ceiling-recessed sliding track.





"Minimalismo Chic: Il Nuovo Paradigma del Design Notturmo"

Benvenuti in un mondo dove la bellezza si trova nella semplicità. L'approccio raffinato di Minimalismo Chic esprime l'essenza stessa del design moderno. Ogni pezzo è una dichiarazione di eleganza senza sforzo, dove linee pulite, forme essenziali e dettagli sofisticati convergono per creare un ambiente notturno di stile e armonia. Scoprite la potenza di un design che sussurra, unisce e incanta. Benvenuti in un mondo dove meno significa di più.

"Chic Minimalism: The New Paradigm of Nighttime Design"

Welcome to a world where beauty is found in simplicity. The refined approach of Chic Minimalism expresses the very essence of modern design. Each piece is a statement of effortless elegance, where clean lines, essential forms, and sophisticated details converge to create a nighttime environment of style and harmony. Discover the power of a design that whispers, unites, and enchants. Welcome to a world where less means more.



STEFANO

linee moderne
modern lines







Qui e nelle pagine precedenti: letto Stefano, con testata in legno in rovere pietra, fascia giroletto e piedini in massello rovere pietra. Comodini della serie Stefano a 1 cassetto con struttura e facciate rovere pietra e gambe in metallo laccate canna di fucile opaco. Con liste divisorie Slates laccate opaco ferro.

Here and on the previous pages: Stefano bed with a headboard in stone oak, bed frame border, and feet in solid stone oak. Bedside tables from the Stefano series with 1 drawer, featuring a structure and fronts in stone oak and matte gunmetal gray lacquered metal legs. With matte iron lacquered Slates dividing strips.

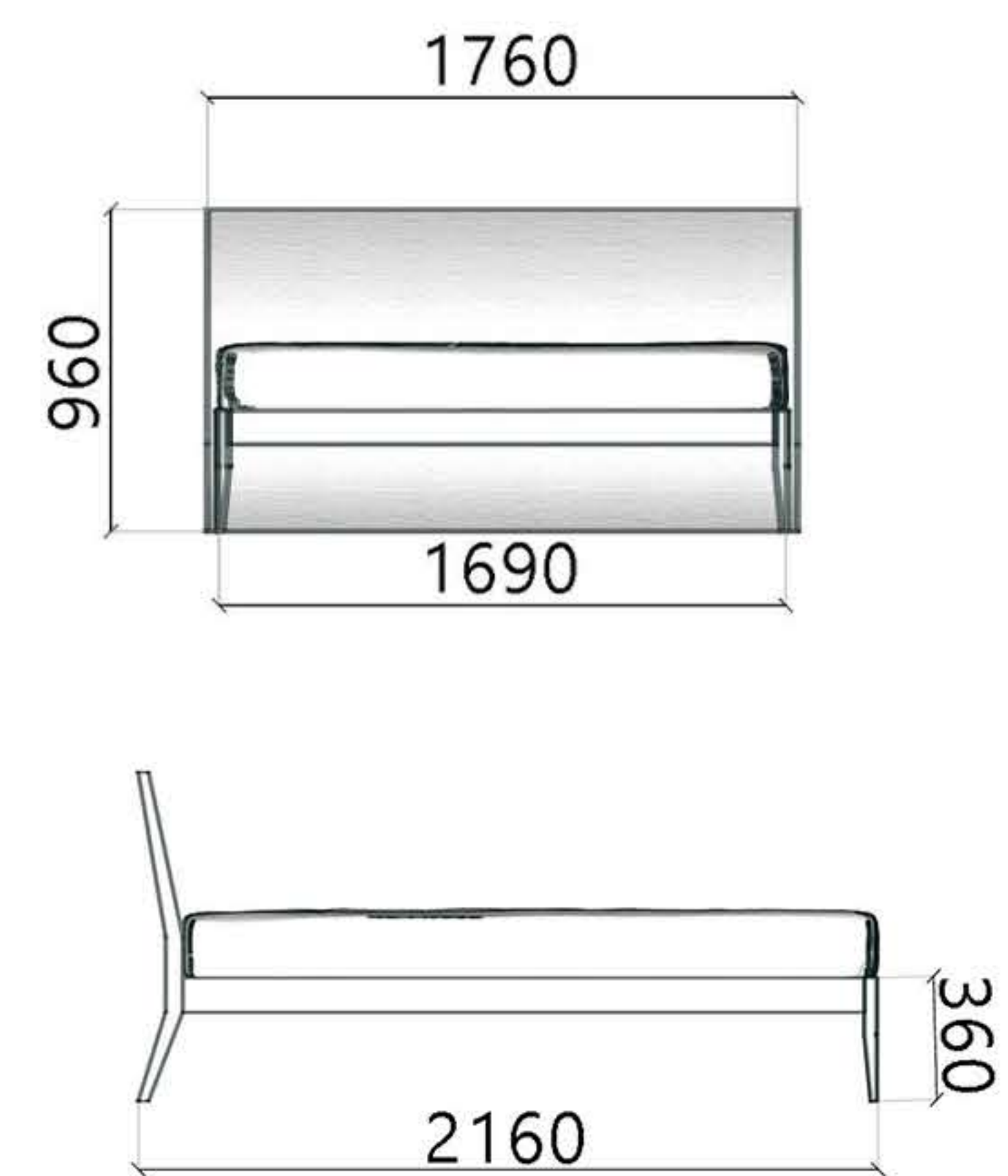





Qui e nelle pagine precedenti armadio a battente della collezione "Tutte le Notti" con ante fresate Cast laccate fumo opaco con apertura premiapri. Particolare del vano beauty in rovere carbone con specchio e illuminato con luci led.

Here and on the previous pages, a hinged doors wardrobe from the "Tutte le Notti" collection with milled Cast doors lacquered in matte smoke with a push-and-pull opening system. Detail of the beauty compartment in charcoal oak with a mirror and illuminated with LED lights.



Dettaglio maniglia incavata della serie Stefano

Detail of the recessed handle from the Stefano series.



Comò a 2 cassettoni della serie Stefano con struttura e facciate rovere pietra e gambe in metallo laccate canna di fucile opaco.

Two-drawer dresser from the Stefano series with a structure and fronts in stone oak and matte gunmetal gray lacquered metal legs.





"Linee Moderne: Design Avanguardista per una Camera da Letto Contemporanea"

Benvenuti in una collezione dove l'estetica moderna si traduce in forme pulite e essenziali. "Linee Moderne" è un'ode al design avanguardista pensato per trasformare la vostra camera da letto in uno spazio contemporaneo. Ogni pezzo è caratterizzato da linee pulite e dettagli moderni, creando un ambiente notturno che riflette l'essenza del contemporaneo. Scoprite come "Linee Moderne" definisce il concetto di stile nella vostra zona notte. Lasciatevi guidare dall'eleganza essenziale di "Linee Moderne".

"Modern Lines: Avant-Garde Design for a Contemporary Bedroom"

Welcome to a collection where modern aesthetics translate into clean and essential forms. "Modern Lines" is an ode to avant-garde design intended to transform your bedroom into a contemporary space. Each piece is characterized by clean lines and modern details, creating a nighttime environment that reflects the essence of the contemporary. Discover how "Modern Lines" defines the concept of style in your sleeping area. Let yourself be guided by the essential elegance of "Modern Lines."

Liste divisorie Slates laccate opaco ferro.

Matte iron lacquered Slates dividing strips.



WIND BASIC

equilibrio zen
zen balance







Qui e nelle pagine precedenti: letto Wind nella versione basic a terra, testata in legno con pannelli laccati bianco opaco. Letto con cassonetto contenitore rientrante sospeso, fascia giroletto laccato bianco opaco e contenitore laccato canna di fucile opaco. Comodini della serie Wind sospesi con struttura e frontali laccati bianco opaco. Incassati nel muro bussolotti della serie Orizzonte laccati bianco opaco con ante vetro a ribalta Halfa dalla cornice alluminio laccata antracite opaco e vetro fumè.

Here and on the previous pages: Wind bed in the basic floor version, wooden headboard with matte white lacquered panels. Bed with a suspended recessed storage box, bed frame border lacquered in matte white, and storage box lacquered in matte gunmetal gray. Suspended bedside tables from the Wind series with a structure and fronts lacquered in matte white. Recessed in-wall cabinets from the Horizon series, lacquered in matte white, with Halfa glass doors featuring a matte anthracite lacquered aluminum frame and smoked glass.

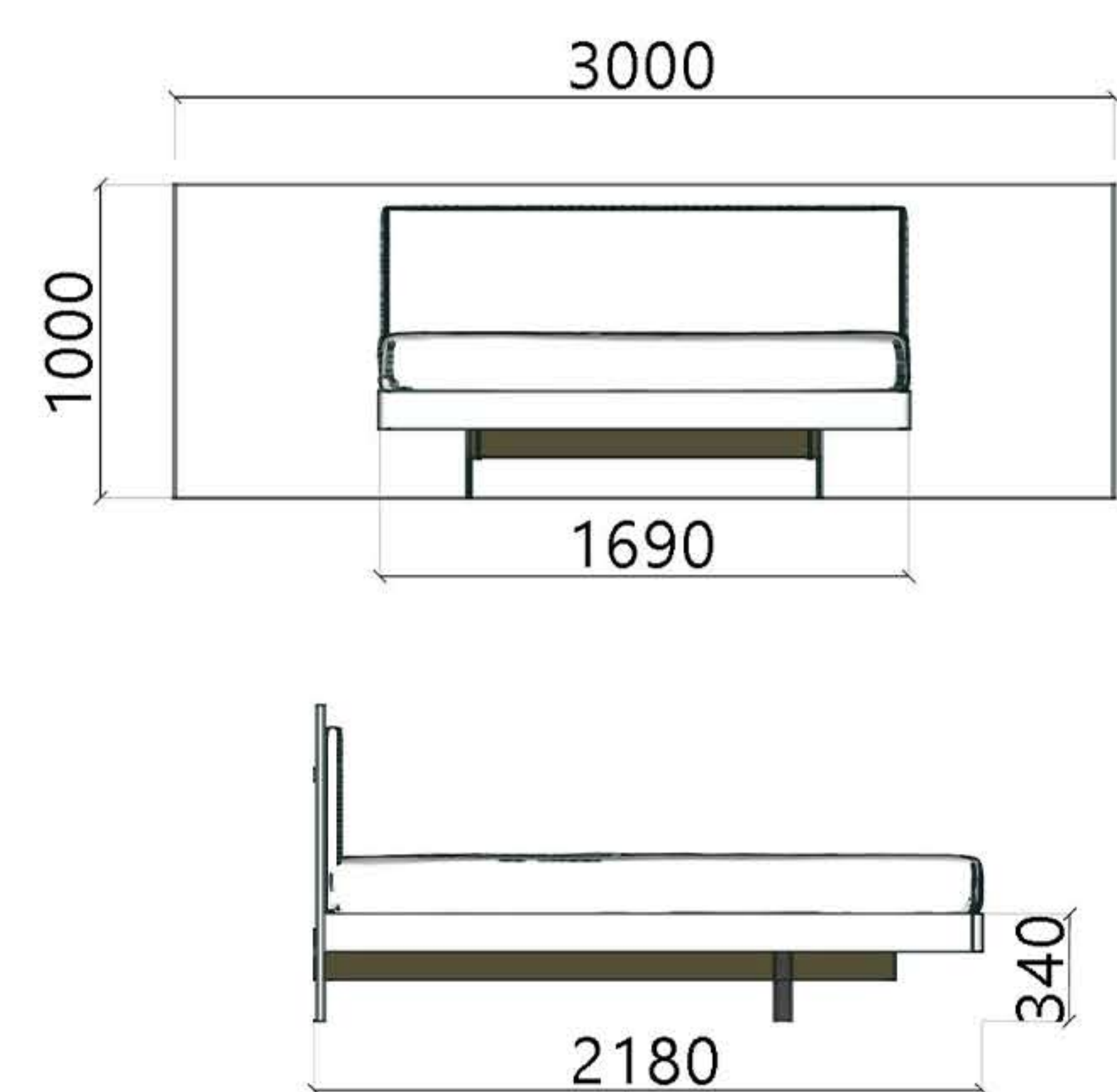





Qui e nelle pagine precedenti armadio a battente della collezione " Tutte le Notti" con ante laccate opaco bianco Basic con lavorazione mansardato. Nell'armadio è presente un vano laccato opaco ferro per alloggiare un tv.

Here and on the previous pages: hinged door wardrobe from the "Tutte le Notti" collection with matte white Basic lacquered doors with a mansard finish. The wardrobe includes a matte iron lacquered compartment to house a TV.

Pouf Dado in microfibra bianco.

White microfiber Dado pouf.





Incassati nel muro bussolotti della serie Orizzonte laccati bianco opaco con ante vetro a Halfa dalla cornice alluminio laccata antracite opaco e vetro fumè. Illuminazione interna con luci led

Recessed in-wall cabinets from the Horizon series, lacquered in matte white, with Halfa glass doors featuring a matte anthracite lacquered aluminum frame and smoked glass. Internal lighting with LED lights.





"Equilibrio Zen: Armonia e Tranquillità nel Tuo Spazio Notturno"

Benvenuti in una collezione dove l'arte di vivere incontra l'essenza del design. "Equilibrio Zen" è una celebrazione dell'armonia e della tranquillità, progettata per trasformare la tua camera da letto in un rifugio di serenità. Ogni pezzo è studiato per creare un equilibrio perfetto tra forme essenziali, materiali naturali e dettagli che ispirano il relax. Scoprite come "Equilibrio Zen" dona al vostro spazio notturno un'atmosfera di calma e equilibrio. Lasciate che questa collezione vi guidi in un viaggio verso la pace e la serenità.

"Zen Balance: Harmony and Tranquility in Your Nighttime Space"

Welcome to a collection where the art of living meets the essence of design. "Zen Balance" is a celebration of harmony and tranquility, designed to transform your bedroom into a haven of serenity. Each piece is crafted to create a perfect balance between essential forms, natural materials, and details that inspire relaxation. Discover how "Zen Balance" infuses your nighttime space with an atmosphere of calm and equilibrium. Let this collection guide you on a journey toward peace and serenity.



GIROLETTO

armonia urbana
urban harmony





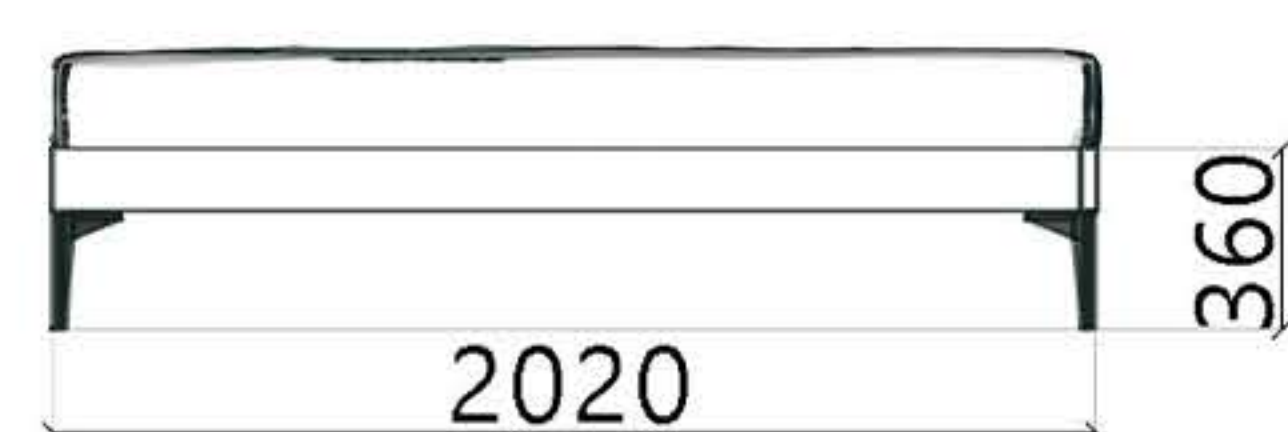
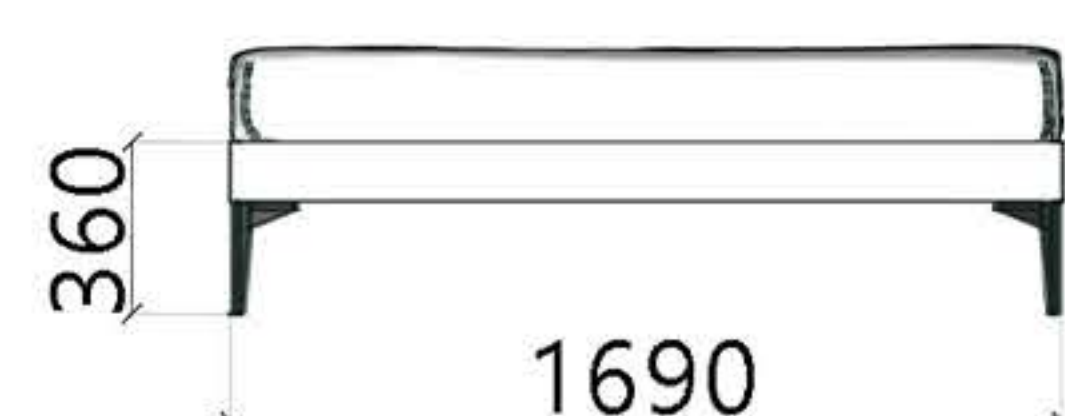

Qui e nelle pagine precedenti: letto Giro con piedini metallici ricoperti e fascia giroletto in rovere grigio. La testata e formata da pannelli Plumb in rovere grigio e pannelli Ritmus nella stessa finitura ma con giochi di movimenti. Comodini della serie Aliante con varianti Ritmus, con struttura laccata bianco opaco e frontali in rovere grigio, poggiano su piedini dello stesso design di quelli del letto color canna di fucile. Comò a 4 cassetti della serie Aliante-ritmus con struttura e frontali in rovere grigio poggia su piedini dello stesso design di quelli del letto color canna di fucile.

Here and on the previous pages: Giro bed with metal-covered legs and a bed frame border in gray oak. The headboard is formed by Plumb panels in gray oak and Ritmus panels in the same finish but with playful movements. Bedside tables from the Aliante series with Ritmus variations, featuring a structure lacquered in matte white and fronts in gray oak, resting on legs of the same design as the bed, in matte gunmetal gray. Four-drawer dresser from the Aliante-Ritmus series with a structure and fronts in gray oak, also resting on legs of the same design as the bed, in matte gunmetal gray.







Qui e nelle pagine precedenti Comodini della serie Aliante con varianti Ritmus, con struttura laccata bianco opaco e frontali in rovere grigio, poggiano su piedini metallici color canna di fucile. Comò a 4 cassetti della serie Aliante-ritmus con struttura e frontali in rovere grigio poggia su piedini metallici color canna di fucile.

Here and on the previous pages: Bedside tables from the Aliante series with Ritmus variations, featuring a structure lacquered in matte white and fronts in gray oak, resting on matte gunmetal gray metallic legs. Four-drawer dresser from the Aliante-Ritmus series with a structure and fronts in gray oak, also resting on matte gunmetal gray metallic legs.





Incassati nel muro bussolotti della serie Orizzonte laccati grafite opaco con ante vetro a Halfa dalla cornice alluminio laccata antracite opaco e vetro fumè o con ante Basic laccate bianco opaco che diventano quasi invisibili. Illuminazione interna con luci led.

Inset wall cabinets from the Orizzonte series, lacquered in matte graphite, with Halfa glass doors featuring a matte anthracite lacquered aluminum frame and smoked glass, or with Basic doors lacquered in matte white, almost becoming invisible. Internal lighting with LED lights.





"Armonia Urbana: Un Design Metropolitano per la Tua Camera da Letto"

Benvenuti in una collezione dove l'energia della città si fonde con l'eleganza del riposo. "Armonia Urbana" è un'espressione di design metropolitano che trasforma la tua camera da letto in un rifugio di stile urbano. Ogni pezzo è studiato per integrarsi armoniosamente in uno spazio contemporaneo, con linee pulite e dettagli sofisticati che riflettono l'essenza della vita urbana. Scoprite come "Armonia Urbana" porta il fascino della città nella vostra zona notte. Lasciatevi avvolgere dall'urban chic di "Armonia Urbana".

"Urban Harmony: Metropolitan Design for Your Bedroom"

Welcome to a collection where the energy of the city merges with the elegance of rest. "Urban Harmony" is an expression of metropolitan design that transforms your bedroom into a refuge of urban style. Each piece is crafted to harmoniously integrate into a contemporary space, with clean lines and sophisticated details reflecting the essence of urban life. Discover how "Urban Harmony" brings the charm of the city into your sleeping area. Let yourself be enveloped by the urban chic of "Urban Harmony."



JASMINE

coccole notturne
nightly cuddles







Qui e nelle pagine precedenti: letto Jasmine, testata a pannelli imbottiti in microfibra color mastice . Letto con cassonetto contenitore , fascia rivestita in microfibra nella stessa finitura della testata. Comodini ,con base metallica laccata canna di fucile opaco, della serie Noah a uno o due cassetti struttura e frontali laccati canna di fucile opaco. Panchetta scendiletto della serie Noah con base metallica laccata canna di fucile opaco e seduta in microfibra mastice.

Here and on the previous pages: Jasmine bed with a headboard featuring padded panels in mastic-colored microfiber. Bed with a recessed storage box, and a border covered in microfiber matching the headboard finish. Bedside tables, with a matte gunmetal gray lacquered metal base, from the Noah series with one or two drawers, featuring a structure and fronts lacquered in matte gunmetal gray. End-of-bed bench from the Noah series with a matte gunmetal gray lacquered metal base and a seat in mastic-colored microfiber.

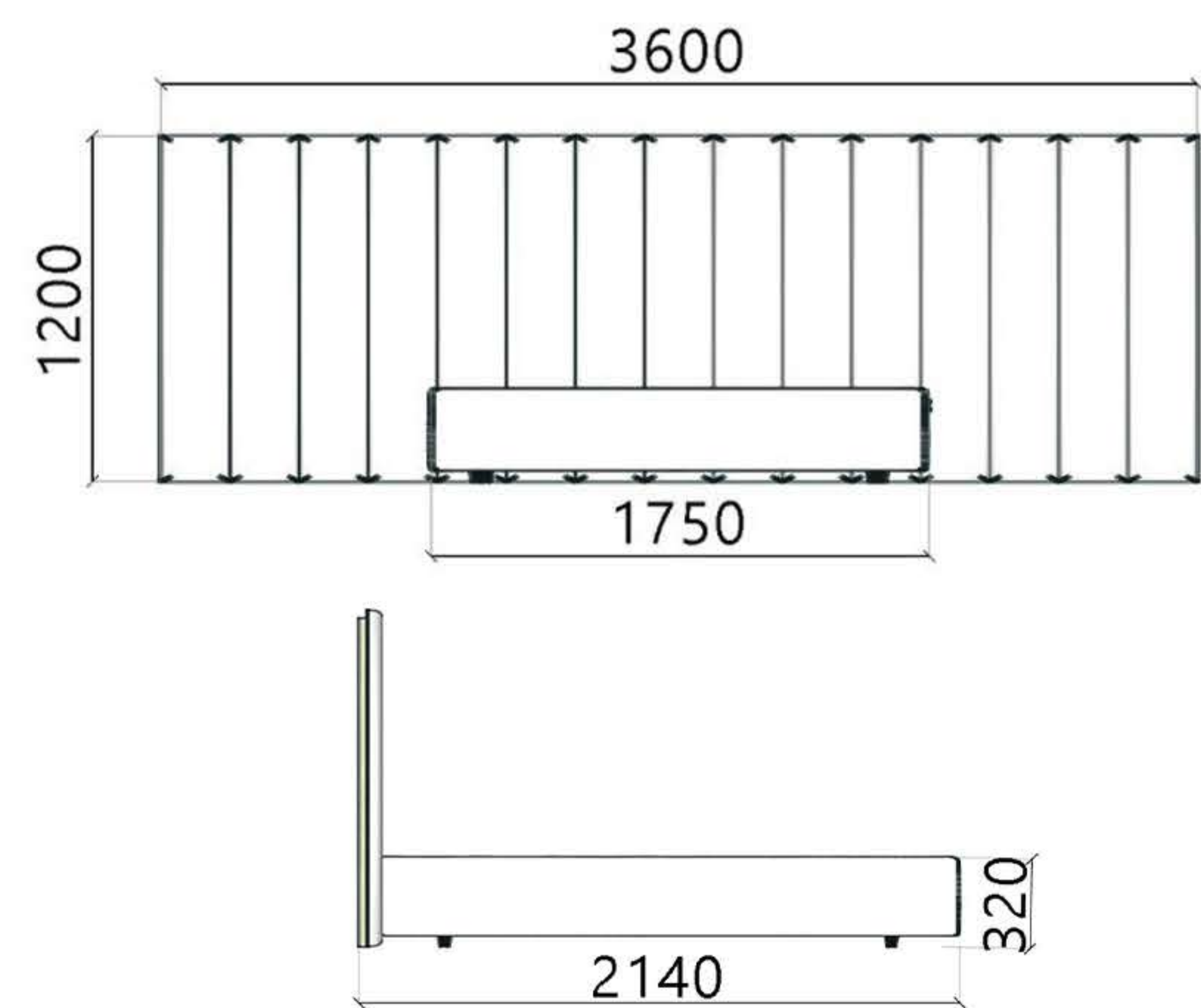





Qui e nelle pagine precedenti cabina armadio della collezione "Tutte le Notti" con struttura laccata ghiaia opaco e accessori della serie exclusive color canna di fucile. Illuminazione con luci led verticali incassate nelle spalle strutturali. Chiusura della cabina con ante scorrevoli con profilo in alluminio canna di fucile opaco e vetri fumè. Le pareti sono rivestite con pannelli in rovere bruciato.

Here and on the previous pages: walk-in closet from the "Tutte le Notti" collection with a structure lacquered in matte gravel and accessories from the Exclusive series in matte gunmetal gray. Vertical LED lighting embedded in the structural shoulders. The closet is closed with sliding doors featuring a matte gunmetal gray aluminum profile and smoked glass. The walls are covered with panels in burned oak.

Comò con base metallica canna di fucile opaco, della serie Noah a tre cassetti struttura e frontali laccati canna di fucile opaco.

Dresser with a matte gunmetal gray lacquered metal base, from the Noah series, featuring three drawers with a structure and fronts lacquered in matte gunmetal gray.



Pannellatura di rivestimento in rovere bruciato con porta integrata nella stessa finitura. Vano rivestito con pannelli laccati mastice opaco.

Paneling in burned oak with an integrated door in the same finish. Compartment covered with panels lacquered in matte mastic.



Libreria centrostanza della serie Noah con struttura metallica canna di fucile e piani in vetro.

Center-room bookcase from the Noah series with a matte gunmetal gray metal structure and glass shelves.





"Coccole Notturne: Avvolgiti nel Calore di un Sonno Dolce e Accogliente"

Benvenuti in una dimensione di comfort dove "Coccole Notturne" diventa il rituale quotidiano per una notte di puro piacere. Ogni pezzo di questa collezione è progettato per cullarti in un abbraccio di morbidezza e relax. Linee morbide e dettagli accoglienti convergono per creare un ambiente notturno che invita al riposo e al benessere. Scoprite come "Coccole Notturne" trasforma la vostra camera da letto in un santuario di serenità, dove ogni notte è un dolce abbraccio di comfort. Lasciatevi avvolgere dalla dolcezza di "Coccole Notturne".

"Nighttime Cuddles: Wrap Yourself in the Warmth of Sweet and Cozy Sleep"

Welcome to a dimension of comfort where "Nighttime Cuddles" becomes the daily ritual for a night of pure pleasure. Each piece in this collection is designed to cradle you in an embrace of softness and relaxation. Soft lines and welcoming details converge to create a nighttime environment that invites rest and well-being. Discover how "Nighttime Cuddles" transforms your bedroom into a sanctuary of serenity, where every night is a sweet embrace of comfort. Let yourself be enveloped by the sweetness of "Nighttime Cuddles."



WIND SPLIT

design avanzato
advanced design







Qui e nelle pagine precedenti: letto Wind nella versione split sospesa, testata in legno con pannelli in rovere bruciato e inserti laccati champagne metallizzato. Letto con cassonetto contenitore rientrante sospeso, fascia giroletto in rovere bruciato e contenitore laccato canna di fucile opaco. Comodini della serie Wind sospesi con struttura e frontali laccati mastice opaco e mensole a croce nella stessa finitura. Applicato alla testata cuscino sfoderabile in microfibra mastice.

Here and on the previous pages: Wind bed in the suspended split version, wooden headboard with panels in burned oak and inserts lacquered in metallic champagne. The bed comes with a recessed suspended storage compartment, a bed frame border in burned oak, and a storage compartment lacquered in matte gunmetal gray. Suspended bedside tables from the Wind series with a structure and fronts lacquered in matte putty and cross-shaped shelves in the same finish. A removable cushion in putty microfiber is applied to the headboard.

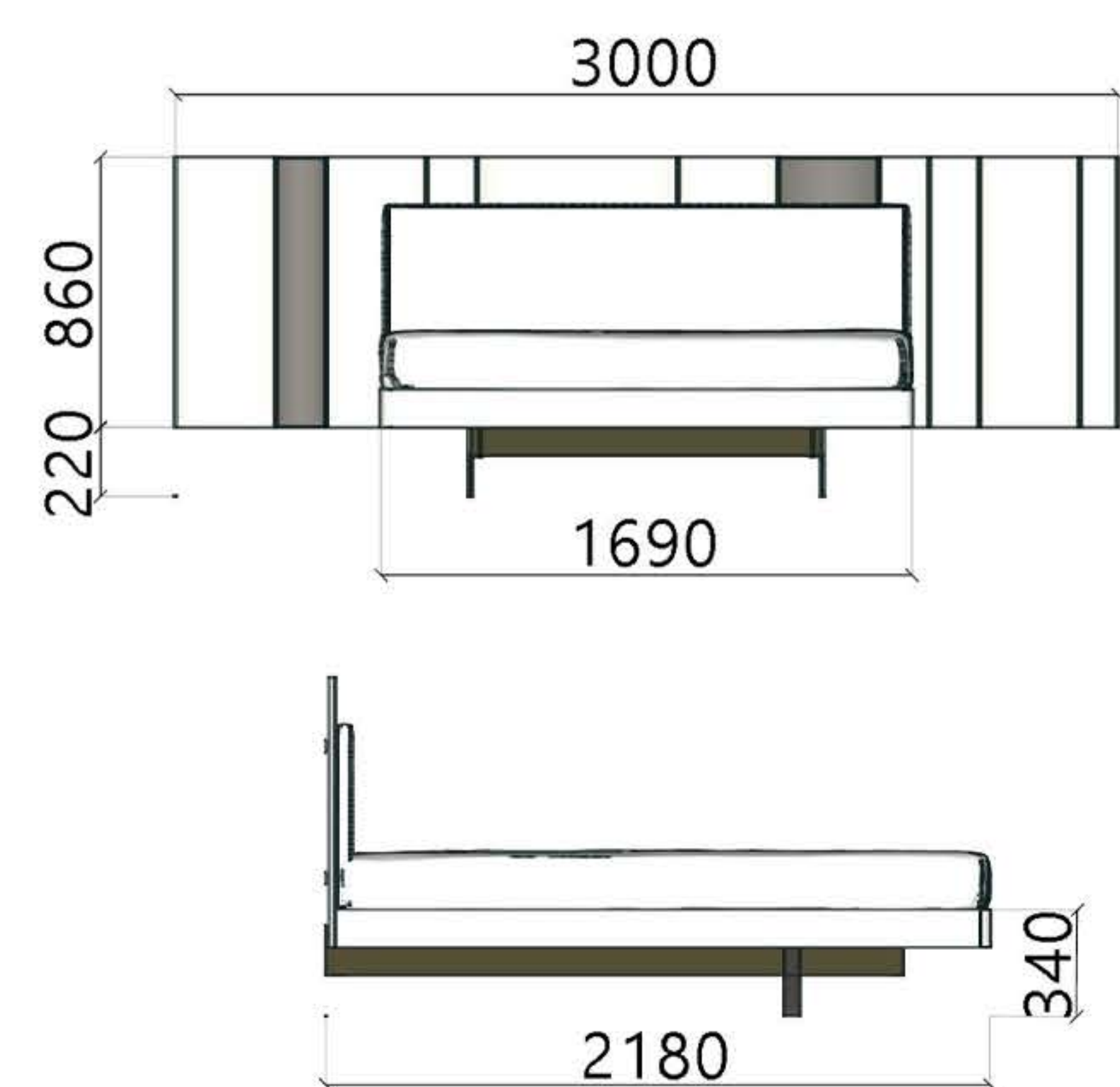





Mensole metalliche con pannelli in rovere bruciato di varie lunghezze. Comò della serie Noah laccato ghiaia opaco con base metallica canna di fucile.

Metal shelves with panels in burned oak of various lengths. Dresser from the Noah series lacquered in matte gravel with a metallic base in matte gunmetal gray.

Qui e nelle pagine precedenti armadio a battente della collezione "Tutte le Notti" con ante laccate opaco ghiaia Cast con lavorazione a fresate. Nell'armadio sono presente 2 ante vetro Halfa con cornice alluminio laccata ghiaia opaco. Nel vano centrale illuminato con luci led incassate, una cassettera a cassetti legno e accessori estraibili metallici color canna di fucile.

Here and in the previous pages: Hinged door wardrobe from the "Tutte le Notti" collection with doors lacquered in matte gravel Cast with grooved processing. In the wardrobe, there are 2 Halfa glass doors with a matte gravel lacquered aluminum frame. In the centrally illuminated compartment with recessed LED lights, there is a dresser with wooden drawers and metallic pull-out accessories in a matte gunmetal gray color.





Letto Wind particolare del cassonetto rientrante e sospeso.

Wind Bed, details of the recessed and suspended storage compartment.

Mensole metalliche canna di fucile con pannelli a muro laccati
ghiaia opaco o rovere bruciato.

*Gunmetal metal shelves with wall-panels lacquered in matte
gravel or burned oak.*





"Design Avanzato: Il Futuro del Comfort e dell'Eleganza"

Benvenuti in una collezione dove il design si spinge oltre i confini dell'innovazione. "Design Avanzato" è un viaggio nel futuro del comfort e dell'eleganza, dove ogni pezzo è una dichiarazione di stile all'avanguardia. Linee innovative e materiali di ultima generazione convergono per creare un ambiente notturno che ridefinisce il concetto di modernità. Scoprite come "Design Avanzato" trasforma la vostra camera da letto in uno spazio all'avanguardia del design. Lasciatevi ispirare dal futuro con "Design Avanzato".

"Advanced Design: The Future of Comfort and Elegance"

Welcome to a collection where design pushes beyond the boundaries of innovation. "Advanced Design" is a journey into the future of comfort and elegance, where each piece is a statement of cutting-edge style. Innovative lines and state-of-the-art materials converge to create a nighttime environment that redefines the concept of modernity. Discover how "Advanced Design" transforms your bedroom into a space at the forefront of design. Let yourself be inspired by the future with "Advanced Design."



QUINTA

semplicità sofisticata
sophisticated simplicity







Qui e nelle pagine precedenti: letto Quinta, testata in legno con pannello posteriore in rovere pietra e pannello avanzato laccati grigio opaco. Letto con cassonetto contenitore rientrante, fascia giroletto in rovere pietra e contenitore laccato canna di fucile opaco. Comodini della serie Aston a 2 cassetti con struttura e facciate laccate verde acqua opaco.

Here and on the previous pages: Quinta bed, wooden headboard with a back panel in stone oak and extended panel lacquered in matte gray. Bed with a recessed storage box, bed frame in stone oak, and storage box lacquered in matte gunmetal gray. Bedside tables from the Aston series with 2 drawers, with a structure and fronts lacquered in matte aqua green.

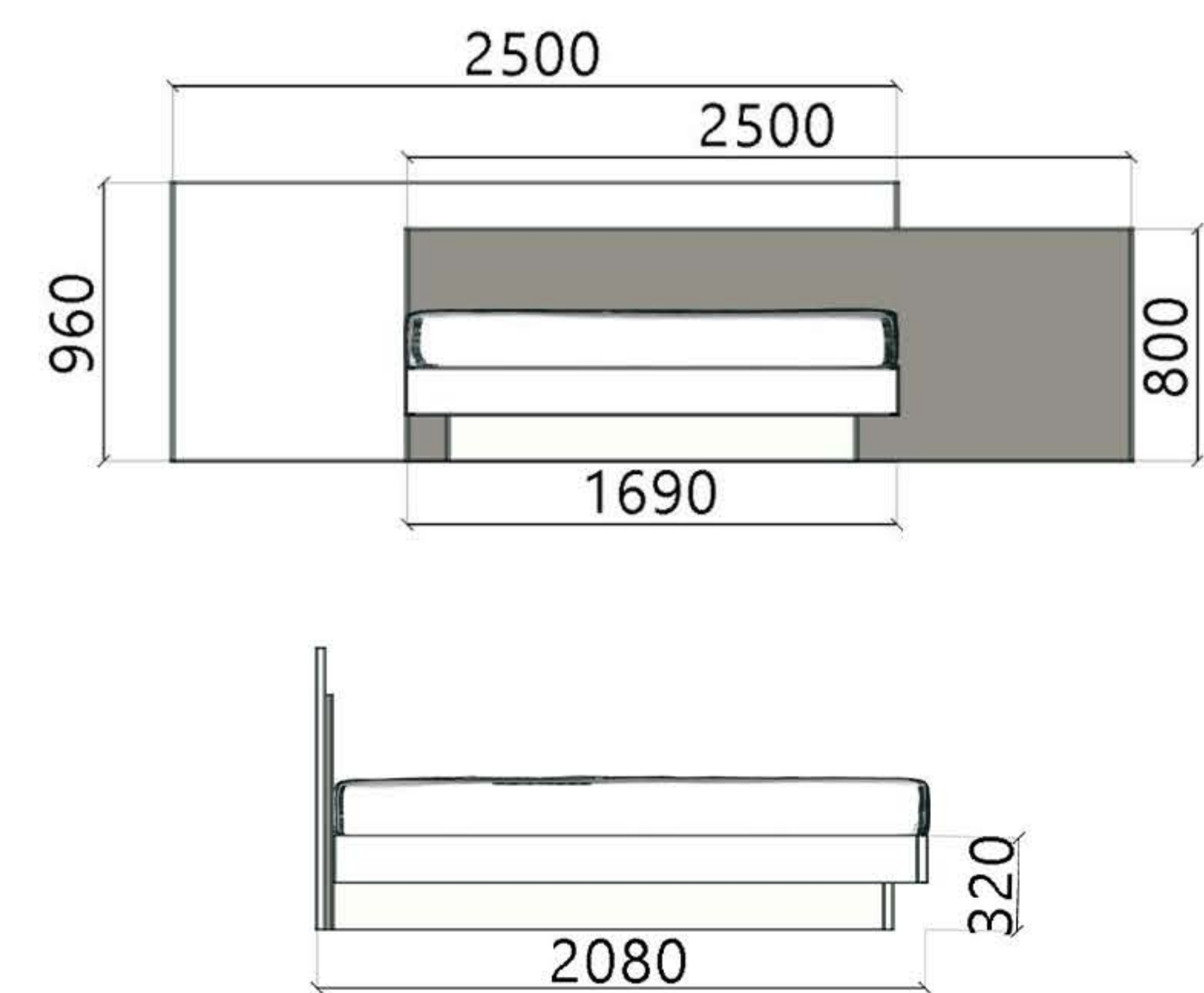



Qui e nelle pagine precedenti armadio a battente della collezione "Tutte le Notti" con ante in essenza Plumb con venature verticali rovere pietra e ante vetro Beta con profilo in alluminio canna di fucile e vetro fumè che lascia intravedere il contenuto anche grazie all'illuminazione interna con luci led. Maniglie incavate Stefano nella stessa finitura.

Here and on the previous pages: swing door wardrobe from the "Tutte le Notti" collection with doors in Plumb essence with vertical veins in stone oak and Beta glass doors with a gunmetal aluminum profile and smoked glass that allows a glimpse of the contents, also thanks to the internal LED lighting. Recessed Stefano handles in the same finish.



Pouf Cubo in ecopelle grigia chiaro.

Light gray eco-leather Cubo pouf.





Comodini arrotondati della serie Aston a 2 cassetti con struttura e facciate laccate verde acqua opaco.

Rounded bedside tables from the Aston series with 2 drawers, featuring a structure and fronts lacquered in matte aqua green.

Dettaglio fascia giroletto.

Detail of the bed frame border.





"Semplicità Sofisticata: L'Eleganza nel Dettaglio Essenziale"

Benvenuti in una collezione dove la bellezza è racchiusa nella sua forma più pura. "Semplicità Sofisticata" è un invito a scoprire l'eleganza nei dettagli essenziali. Ogni pezzo è una celebrazione di linee pulite e forme raffinate, creando un ambiente notturno dove la sofisticatezza si esprime attraverso la sua stessa semplicità. Scoprite come questa collezione trasforma la vostra camera da letto in uno spazio di raffinato minimalismo senza tempo. Lasciatevi avvolgere dalla bellezza senza sforzo di "Semplicità Sofisticata".

"Sophisticated Simplicity: Elegance in Essential Details"

Welcome to a collection where beauty is encapsulated in its purest form. "Sophisticated Simplicity" is an invitation to discover elegance in essential details. Each piece is a celebration of clean lines and refined forms, creating a nighttime environment where sophistication expresses itself through its own simplicity. Discover how this collection transforms your bedroom into a space of refined timeless minimalism. Let yourself be enveloped by the effortless beauty of "Sophisticated Simplicity."



JASMINE LEGNO

versatilità stilistica
stylistic versatility











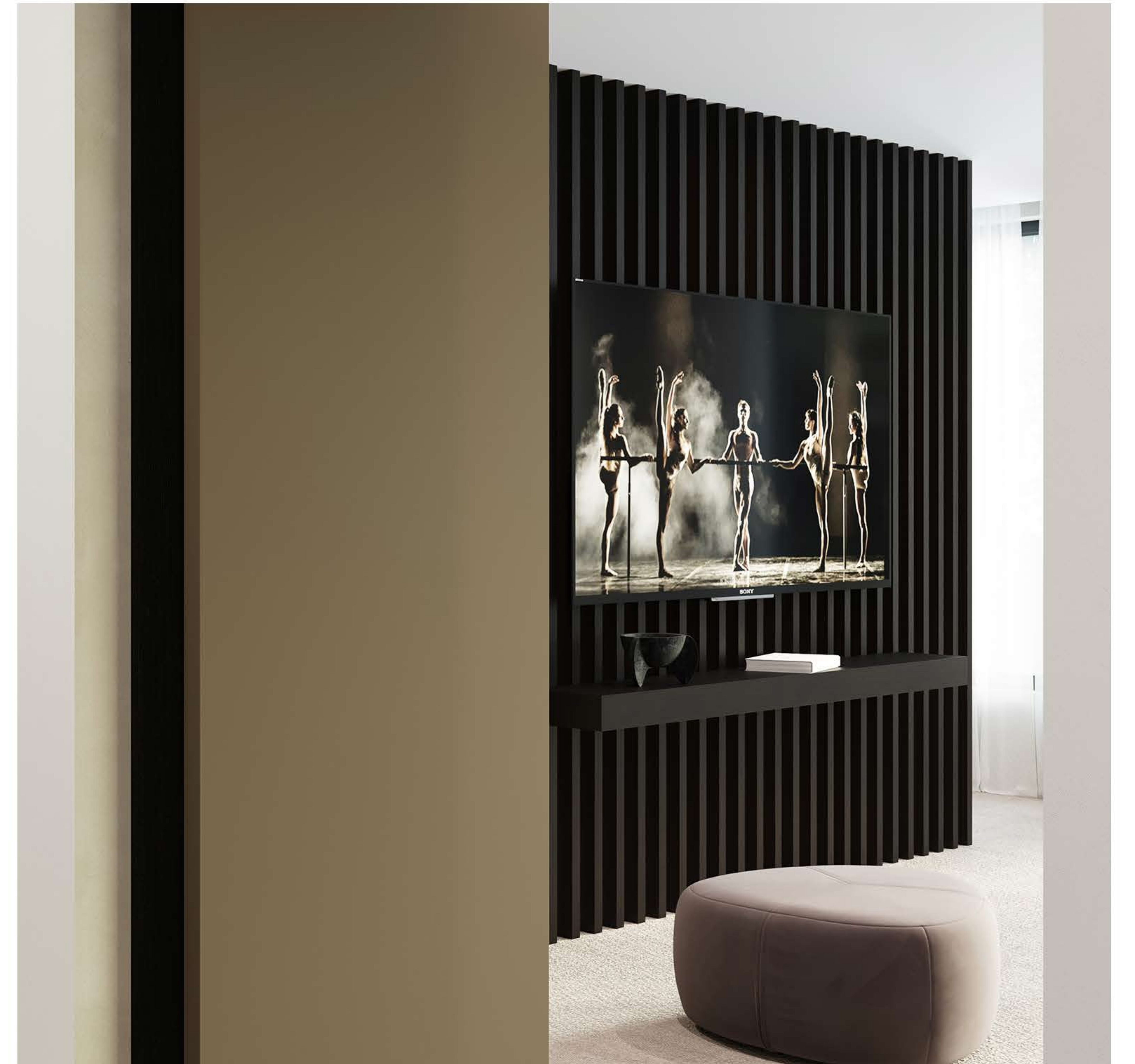



"Versatilità Stilistica: Esplora un Mondo di Opzioni"

Benvenuti in una collezione dove l'eleganza si sposa con la flessibilità. Qui, vi invitiamo a esplorare un mondo di opzioni dove lo stile si adatta ai vostri gusti personali. Scopri come la versatilità diventa protagonista, permettendoti di creare l'ambiente notturno dei tuoi sogni. Sia che tu cerchi un look contemporaneo o un tocco di tradizione, la collezione "Versatilità Stilistica" offre un'ampia gamma di opzioni per soddisfare ogni esigenza di design. Preparati a scoprire l'infinita versatilità dello stile con la nostra collezione di letti.

"Stylistic Versatility: Explore a World of Options"

Welcome to a collection where elegance meets flexibility. Here, we invite you to explore a world of options where style adapts to your personal tastes. Discover how versatility takes center stage, allowing you to create the nighttime environment of your dreams. Whether you're seeking a contemporary look or a touch of tradition, the 'Stylistic Versatility' collection offers a wide range of options to meet every design need. Get ready to discover the endless versatility of style with our collection of beds."

SELENE

sogno imbottito
padded dream





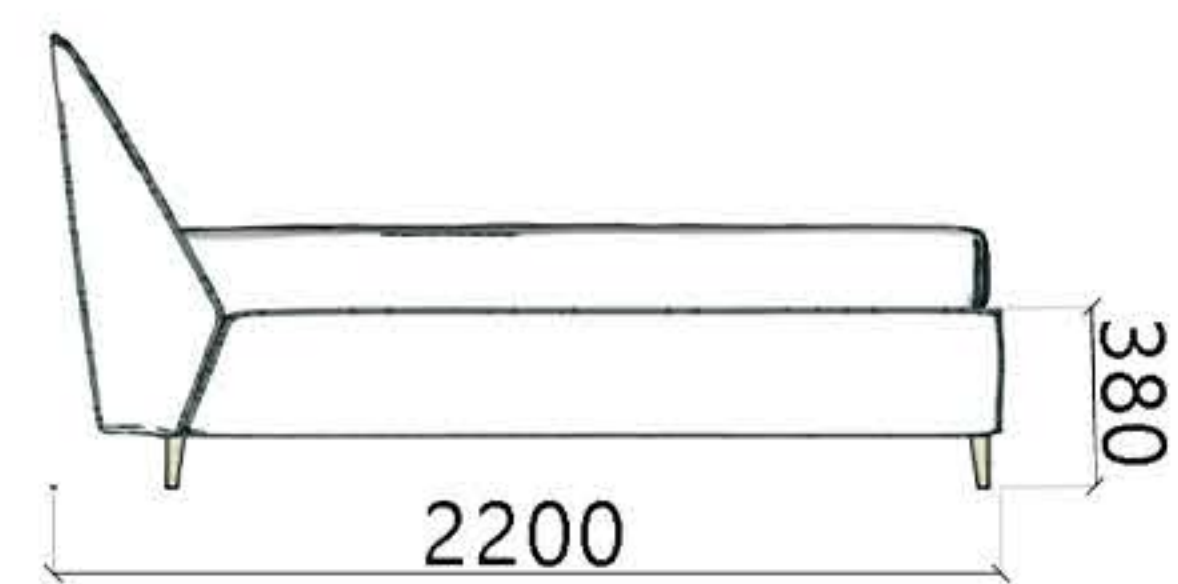
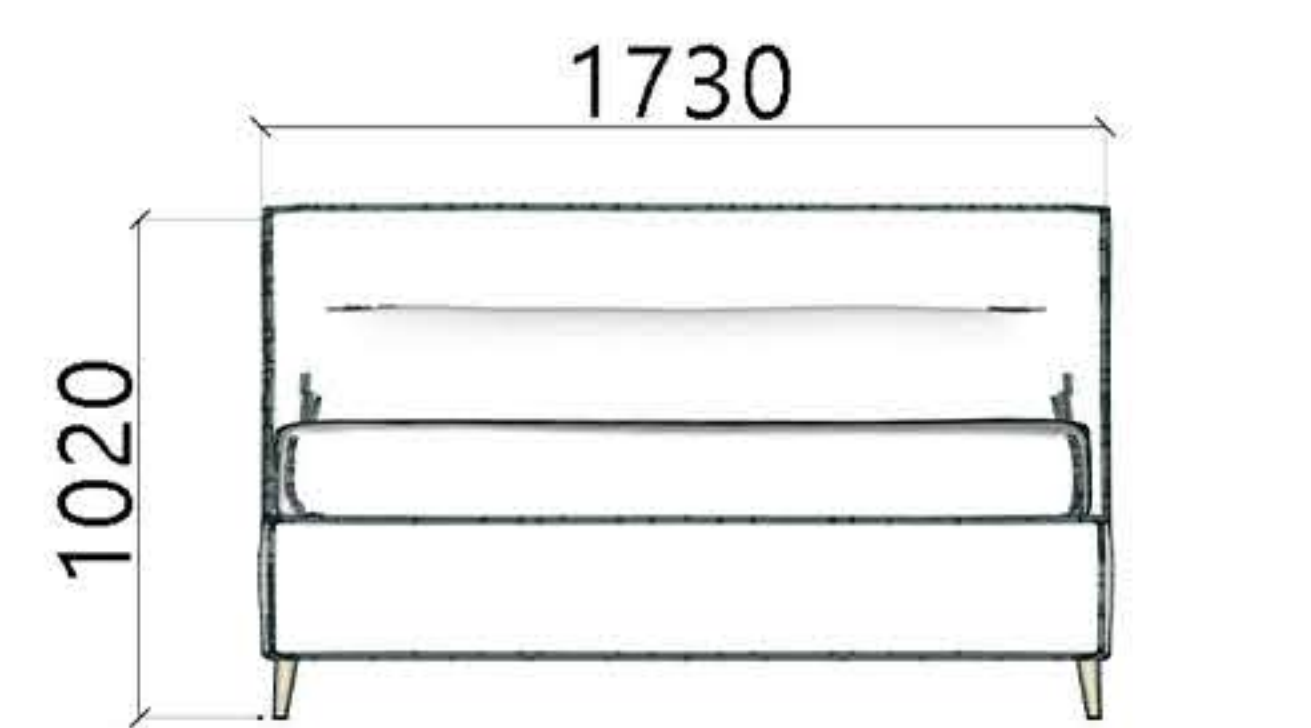

Qui e nelle pagine precedenti: letto Selene con testata imbottita. Letto con cassonetto contenitore , fascia giroletto rivestita in microfibra. Comodini della serie Aston con struttura e frontali laccati grafite ,top di finitura superiore in gres statuario. Comò a 2 cassetti e 1 cassettone della serie Aston con struttura e frontali laccati grafite,top di finitura superiore in gres statuario. Pouf cilindrico in microfibra .

Here and on the previous pages: Selene bed with an upholstered headboard. Bed with a recessed storage box, bed frame border covered in microfiber. Bedside tables from the Aston series with a structure and fronts lacquered in graphite, and an upper finishing top in statuary stoneware. Two-drawer dresser and one chest of drawers from the Aston series with a structure and fronts lacquered in graphite, and an upper finishing top in statuary stoneware. Cylindrical pouf in microfiber.





Qui e nelle pagine precedenti cabina armadio a pannelli della collezione "Tutte le Notti" pannelli a muro laccati grafite opaco. Ripiani spostabili e cassettiere nella stessa finitura.

Here and on the previous pages: wall panel wardrobe from the "Tutte le Notti" collection, wall panels lacquered in matte graphite. Adjustable shelves and drawers in the same finish.



Dettaglio box contenitore letto Selene

Detail of the storage box for the Selene bed





Pannellatura a muro Ritmus in rovere grigio. Bussolotti a 1 cassetto sospesi della serie Orizzonte laccati mastice Opaco. Specchiera a mezzaluna retro illuminata. Sedia Artù in rovere grigio con seduta in ecopelle.

Wall paneling Ritmus in gray oak. Suspended wall cabinets with 1 drawer from the Orizzonte series, lacquered in matte mastic. Backlit half-moon-shaped mirror. Artù chair in gray oak with a seat in faux leather.





"Sogno Imbottito: L'Eleganza del Riposo Avvolto nella Morbidezza"

Benvenuti in una collezione dove ogni notte diventa un sogno avvolto nell'abbondanza di morbidezza. "Sogno Imbottito" è un invito a immergersi in un'esperienza di riposo avvolgente, dove ogni pezzo è progettato per offrire il massimo comfort con un tocco di eleganza. Linee sinuose e materiali soffici convergono per creare un ambiente notturno che culla i vostri sogni con lusso e stile. Scoprite come "Sogno Imbottito" rende ogni notte un'esperienza di puro raffinemento e relax. Lasciate che i vostri sogni prendano forma con l'eleganza del "Sogno Imbottito".

"Padded Dream: The Elegance of Rest Wrapped in Softness"

Welcome to a collection where every night becomes a dream enveloped in an abundance of softness. "Padded Dream" is an invitation to immerse yourself in a comforting rest experience, where each piece is designed to offer maximum comfort with a touch of elegance. Curvaceous lines and soft materials converge to create a nighttime environment that cradles your dreams with luxury and style. Discover how "Padded Dream" turns every night into an experience of pure refinement and relaxation. Let your dreams take shape with the elegance of "Padded Dream."



WIND RITMUS

illumina la notte
illuminate the night









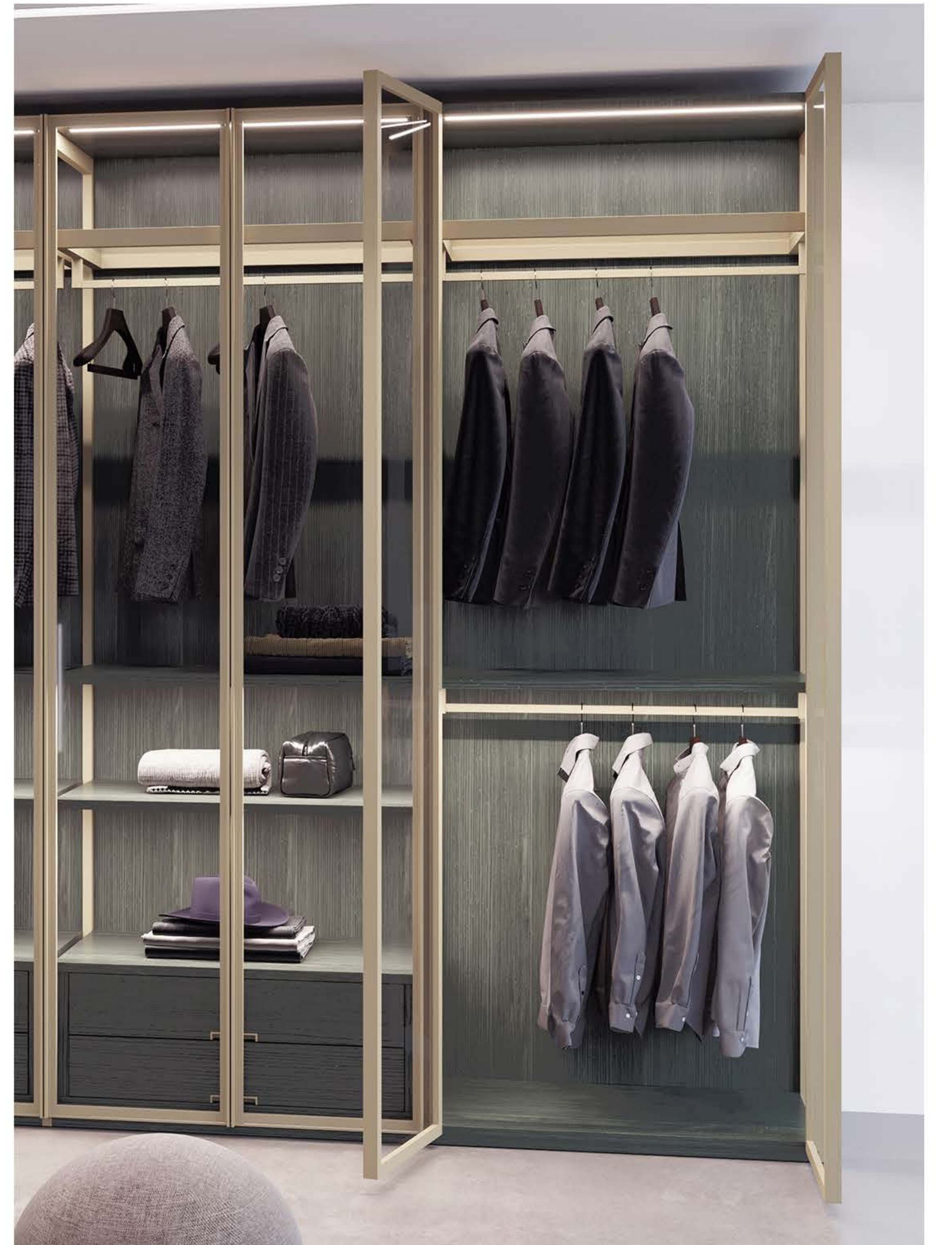





"Illumina la Notte: Scopri il Comfort Radioso"

Benvenuti in una collezione dove il comfort incontra l'eleganza luminosa. Qui, vi invitiamo a esplorare un mondo in cui ogni letto è un faro di relax e stile. Scoprite come i nostri letti illuminano la vostra esperienza notturna, offrendo un mix di comfort e sofisticazione. Che siate attratti da un bagliore moderno o da una radiosa classicità, la collezione "Illumina la Notte" offre una varietà di opzioni per soddisfare le vostre preferenze di design.

"Illuminate the Night: Discover Radiant Comfort"

Welcome to a collection where comfort meets luminous elegance. Here, we invite you to explore a world where each bed is a beacon of relaxation and style. Discover how our beds light up your nighttime experience, offering a blend of comfort and sophistication. Whether you're drawn to a modern glow or a radiant classicism, the 'Illuminate the Night' collection provides a variety of options to meet your design preferences.

GABBIANO

visione moderna
modern vision







Qui e nelle pagine precedenti: letto Gabbiano, testata in legno, con pannello inclinato dove possono essere alloggiati luci led di lettura, e fascia giroletto laccati ghiaia opaco con piedini metallici color bronzo. Comodini della serie Aliante a 2 cassetti sospesi con struttura e facciate in rovere sahara. Tavolino Tulip con base laccata bronzo metallizzato e pianom in rovere sahara.

Here and on the previous pages: Gabbiano bed, wooden headboard with an inclined panel where reading LED lights can be accommodated, and a bed frame border lacquered in matte gravel with metallic legs in bronze color. Suspended bedside tables from the Aliante series with 2 drawers, featuring a structure and fronts in sahara oak. Tulip table with a metallic bronze lacquered base and a top in sahara oak.

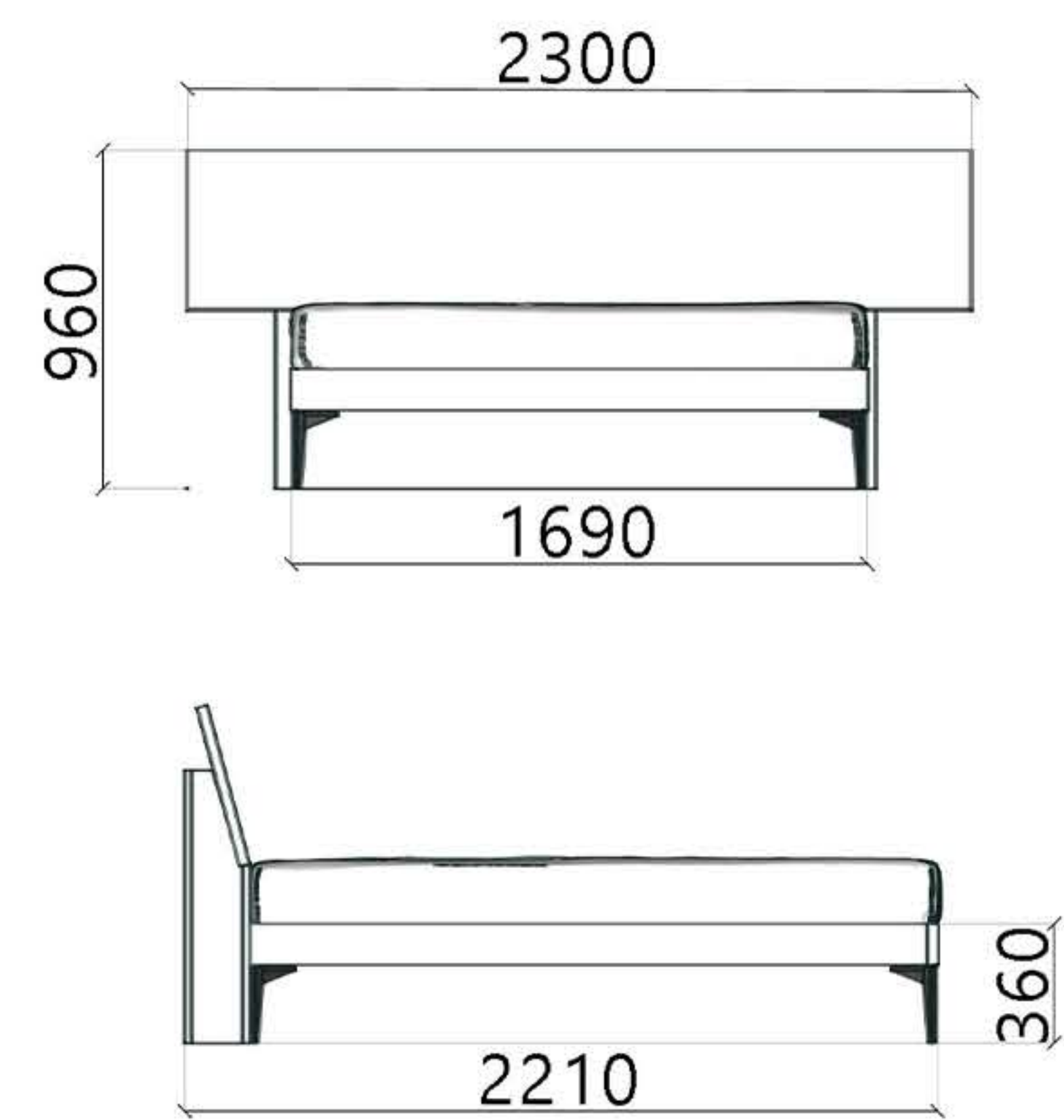



Qui e nelle pagine precedenti armadio a battente della collezione " Tutte le Notti" con ante in essenza Plumb con venature verticali rovere sahara alcune con innesto di una teka wally. L'armadio è interrotto da una nicchia laccata mastice con porta per accesso a locale adiacente.

Here and on the previous pages: Hinged door wardrobe from the "Tutte le Notti" collection with doors in Plumb wood with vertical veins in Sahara oak, some with the addition of a Wally showcase. The wardrobe is interrupted by a niche lacquered in putty color with a door for access to an adjacent room.



Teka Wally bronzo metallizzato con led e vetro di chiusura.

Wally Showcase in metallic bronze with LED lights and closing glass.





Nella serie Aliante sono presenti molteplici elementi : comodini, comò e settimini e vi è la possibilità di scegliere tra elementi sospesi oppure poggiati a terra scegliendo il piedino che meglio si ambienta nell' arredo. Qui comò e settimino in rovere sahara con piedini Aliante laccati color bronzo metallizzato.

*In the Aliante series, there are multiple elements: bedside tables, dressers, and tallboys, and you have the option to choose between suspended elements or those placed on the floor, selecting the leg that best complements the furnishings.
Here, the dresser and tallboy are in Sahara oak with Aliante legs lacquered in metallic bronze.*



Settimino Aliante con teka Wally.
Aliante Dresser with Wally Showcase.





"Visione Moderna: Design Che Ridefinisce il Concetto di Stile"

Benvenuti in una collezione dove la visione moderna prende forma attraverso linee audaci e dettagli innovativi. "Visione Moderna" è un'esplorazione del design contemporaneo che ridefinisce il concetto di stile nella tua camera da letto. Ogni pezzo è un'opera d'arte funzionale, dove forme avanguardiste e materiali innovativi convergono per creare un ambiente notturno unico e all'avanguardia. Scoprite come "Visione Moderna" trasforma la vostra camera da letto in uno spazio di puro stile e innovazione. Lasciatevi ispirare dalla modernità di "Visione Moderna".

"Modern Vision: Design Redefining the Concept of Style"

Welcome to a collection where modern vision takes shape through bold lines and innovative details. "Modern Vision" is an exploration of contemporary design that redefines the concept of style in your bedroom. Each piece is a functional work of art, where avant-garde forms and innovative materials converge to create a nighttime environment that is both unique and cutting-edge. Discover how "Modern Vision" transforms your bedroom into a space of pure style and innovation. Let yourself be inspired by the modernity of "Modern Vision."



VALENTINA

dolce dormire
sweet sleep







Qui e nelle pagine precedenti: letto Valentina, testata imbottita trapuntata in ecopelle ghiaia. Letto con cassonetto contenitore, fasce arrotondate rivestite in ecopelle ghiaia. Comodini della serie Valentina a 2 cassetti con struttura e facciate arrotondate in rovere bruciato. Liste in rovere bruciato Slates fissate a parete e a soffitto.

Here and on the previous pages: Valentina bed, tufted upholstered headboard in mink faux leather. Bed with a recessed storage box, rounded bands covered in mink faux leather. Bedside tables from the Valentina series with 2 drawers, featuring a structure and rounded fronts in burned oak. Burned oak Slates fixed to the wall and ceiling.

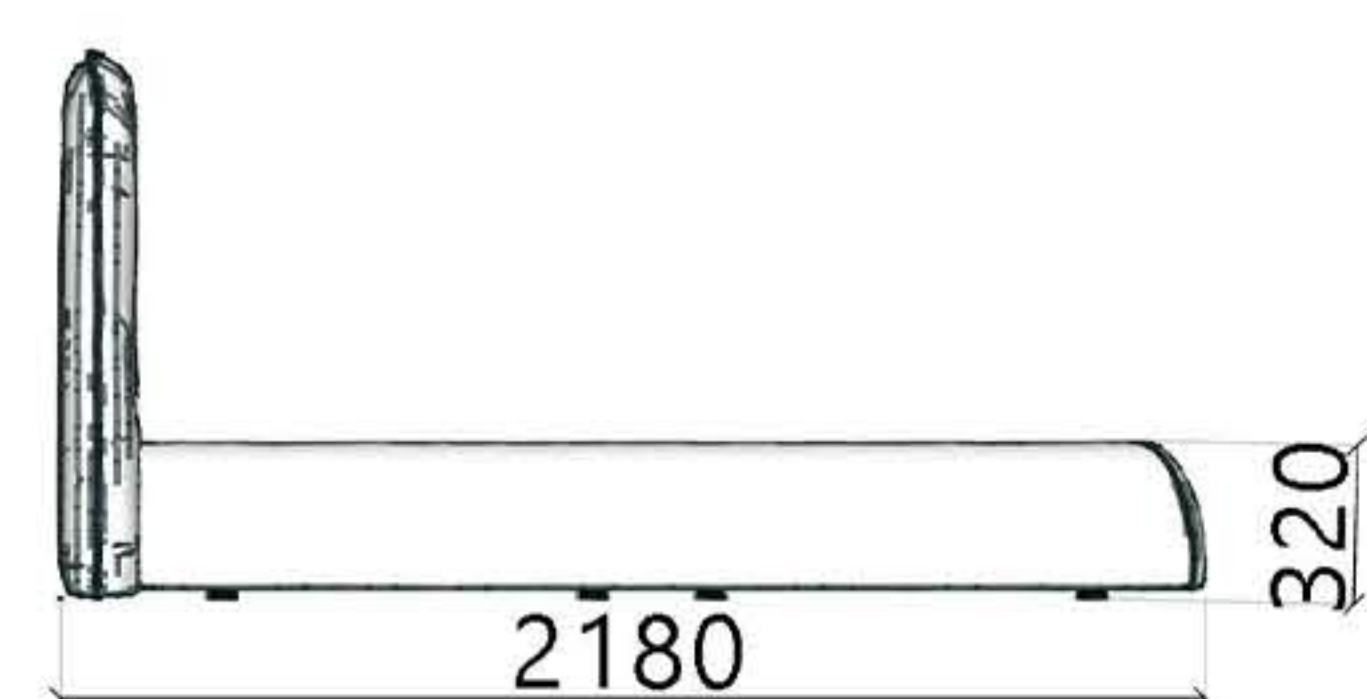
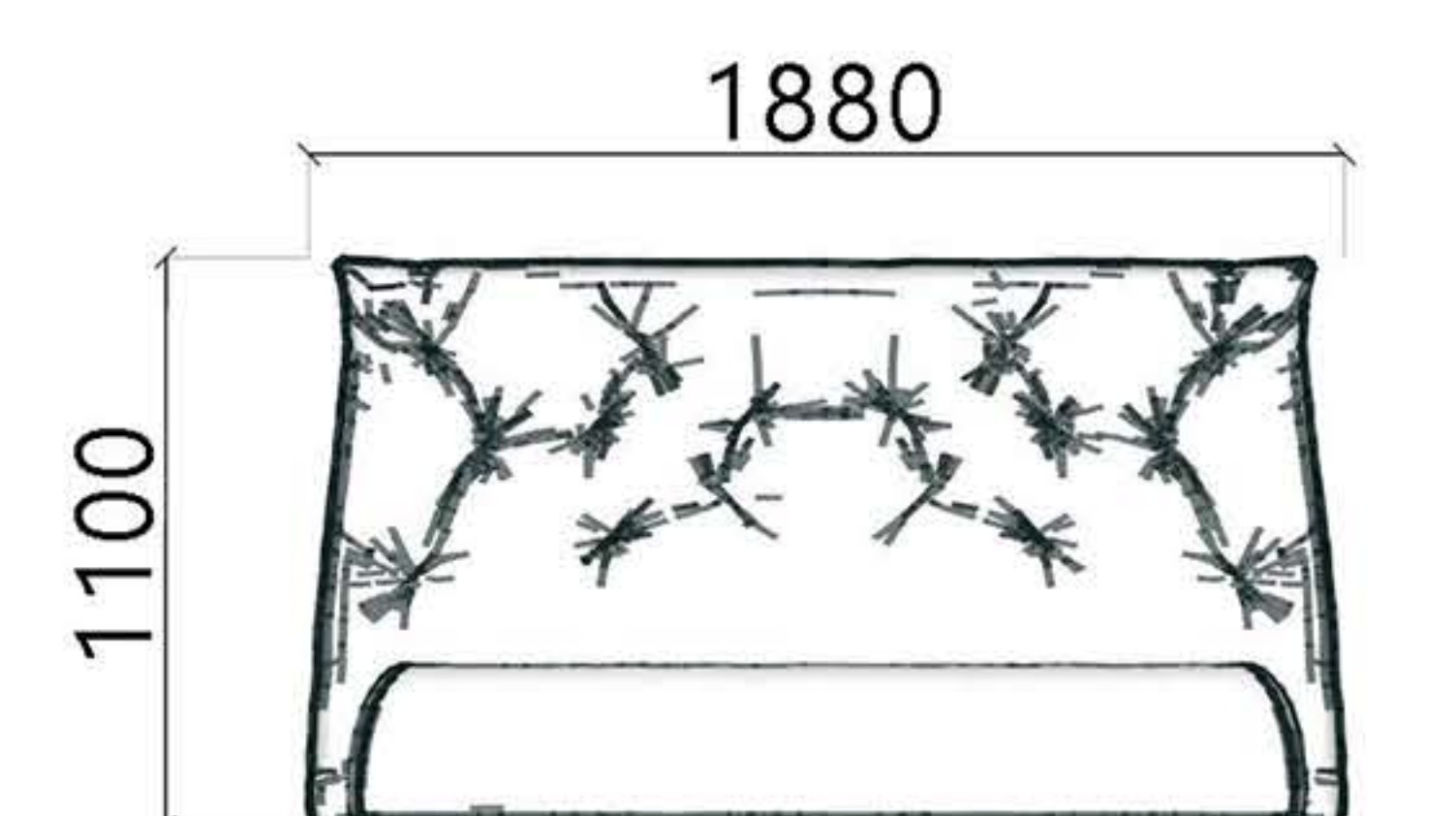





Dettaglio anta centrale Plumb in rovere bruciato.

Detail of the central Plumb door in burned oak.



Qui e nelle pagine precedenti armadio della collezione " Tutte le Notti" con ante a battente Basic laccate ghiaia opaco abbinato a un' anta centrale scorrevole Plumb in rovere bruciato di forte spessore predisposta per l'aggancio di una televisione. Particolare dell'anta scorrevole aperta davanti alle ante a battente.

Here and on the previous pages: wardrobe from the "Tutte le Notti" collection with swing doors Basic lacquered in matte gravel, paired with a central sliding door Plumb in thick burned oak, equipped for mounting a television. Detail of the open sliding door in front of the swing doors.

Armadio a battente Beta della collezione " Tutte le Notti" con spalle laterali e ante vetro Beta con profilo in alluminio canna di fucile e vetro fumè che lasciano intravedere il contenuto anche grazie all'illuminazione interna con luci led.

Swing door wardrobe Beta from the "Tutte le Notti" collection with side panels and Beta glass doors with a matte gunmetal gray aluminum profile and smoked glass, allowing a glimpse of the contents, also enhanced by internal LED lighting.



Comò Valentina a 3 cassetti con struttura e facciata curva in rovere bruciato.

Three-drawer dresser Valentina with structure and curved front in burned oak.





"Dolce Dormire: Il Benessere di un Riposo Avvolto in Morbidezza"

Benvenuti in una collezione dove il riposo diventa un dolce abbraccio di serenità. "Dolce Dormire" è un invito a immergersi in un'esperienza di sonno avvolgente, dove ogni pezzo è pensato per offrire il massimo comfort con un tocco di raffinatezza. Linee accoglienti e materiali soffici convergono per creare un ambiente notturno che culla i vostri sogni con lusso e stile. Scoprite come "Dolce Dormire" rende ogni notte un'esperienza di puro benessere e relax. Lasciatevi avvolgere dalla dolcezza di un riposo raffinato con "Dolce Dormire".

"Sweet Sleep: The Wellness of Rest Wrapped in Softness"

Welcome to a collection where rest becomes a sweet embrace of serenity. "Sweet Sleep" is an invitation to immerse yourself in a cocooning sleep experience, where each piece is designed to offer maximum comfort with a touch of refinement. Cozy lines and soft materials converge to create a nighttime environment that cradles your dreams with luxury and style. Discover how "Sweet Sleep" turns every night into an experience of pure well-being and relaxation. Let yourself be enveloped by the sweetness of refined rest with "Sweet Sleep."



JASMINE KING

soffici abbracci
soft hugs







Qui e nelle pagine precedenti: letto Jasmine, testata king con pannelli imbottiti doppi in microfibra color fango e pannelli laterali in rovere color tabacco. Letto con fascia rivestita in microfibra nella stessa finitura della testata. Comodini della serie Wally a due cassetti struttura e frontali laccati fango con maniglia canna di fucile.

Here and in the previous pages: Jasmine bed, king-size headboard with double padded panels in mud-colored microfiber and side panels in tobacco colored oak. Bed with a band covered in microfiber in the same finish as the headboard. Wally bedside tables with two drawers, structure, and fronts lacquered in mud color with gunmetal handles.

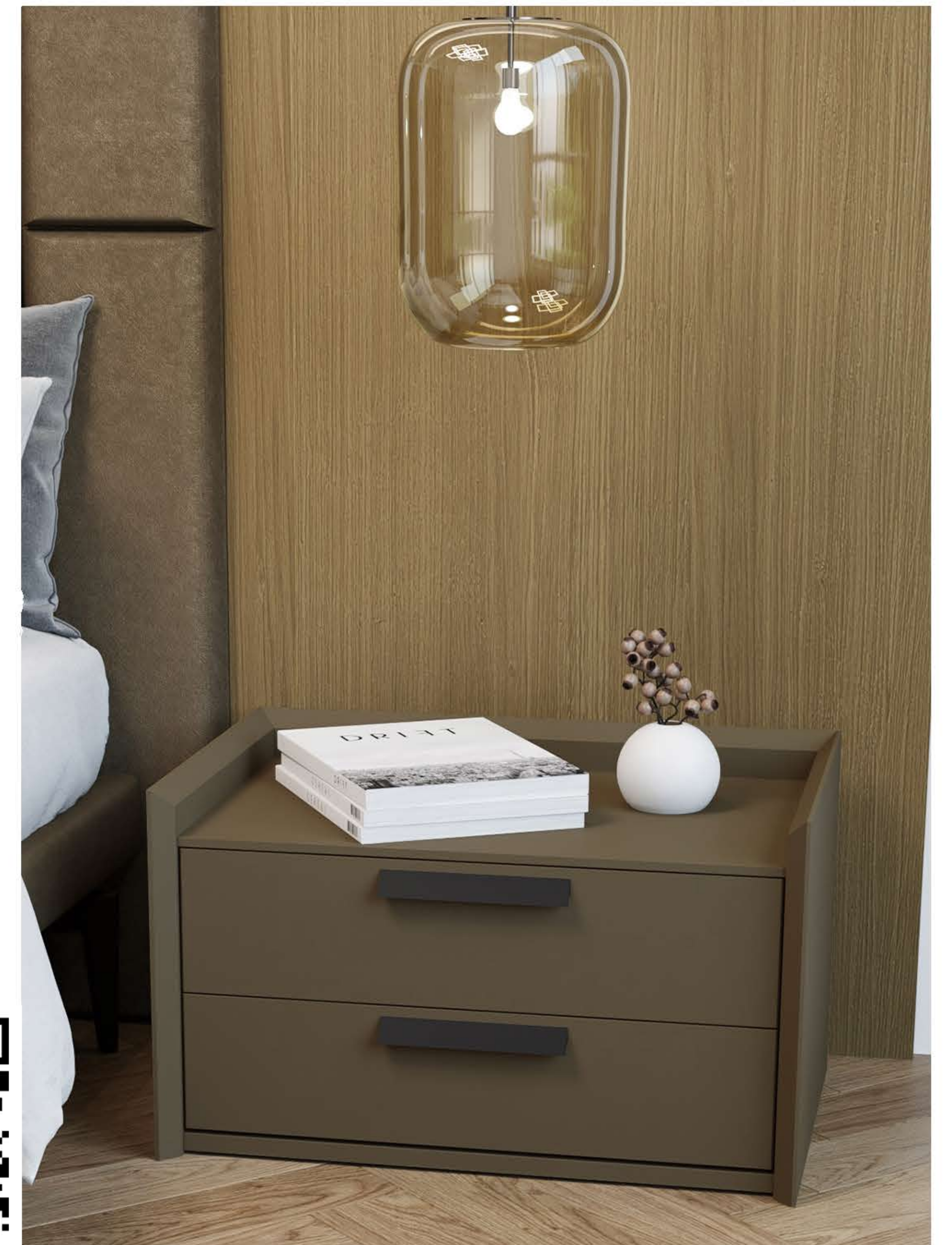
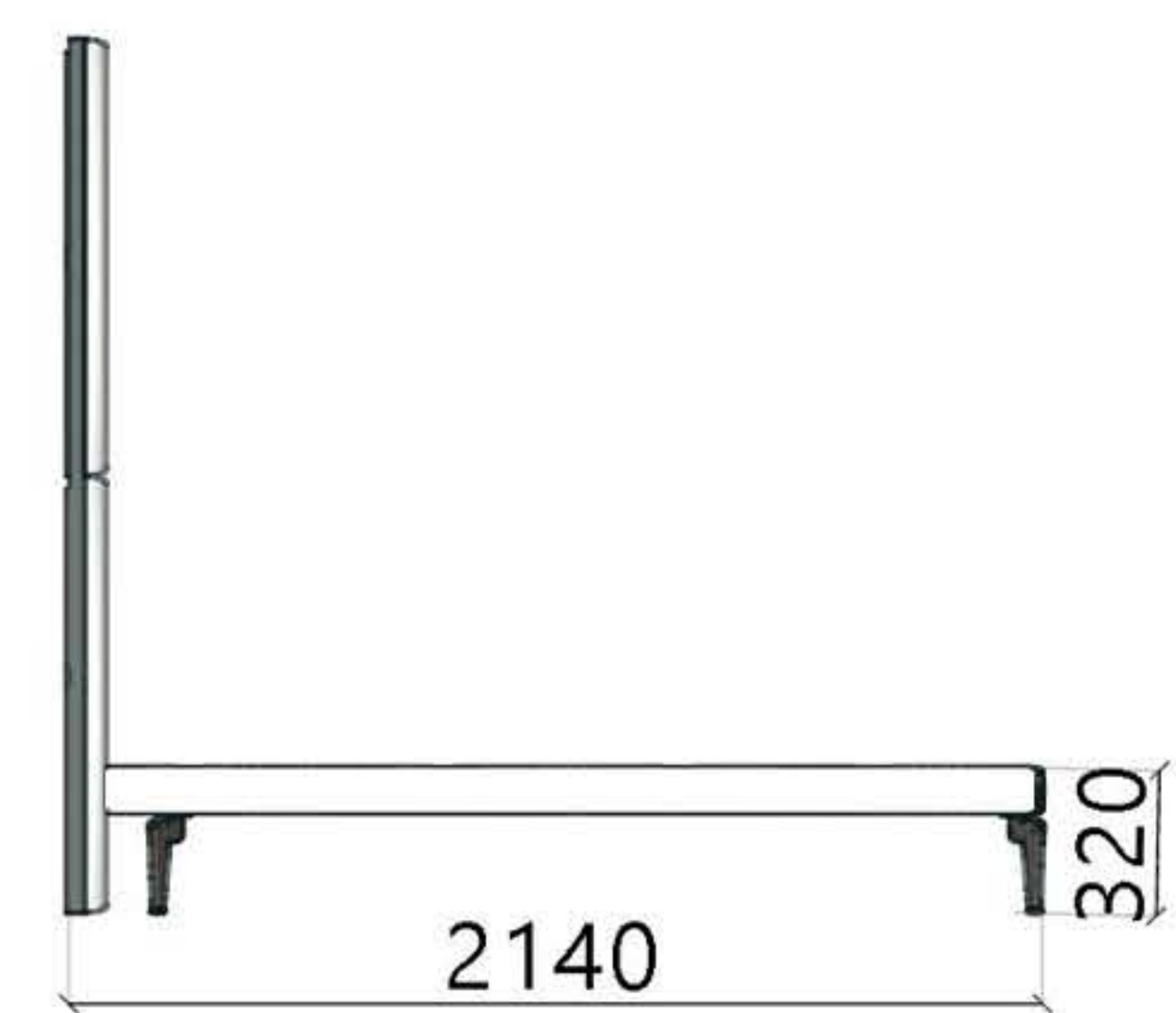
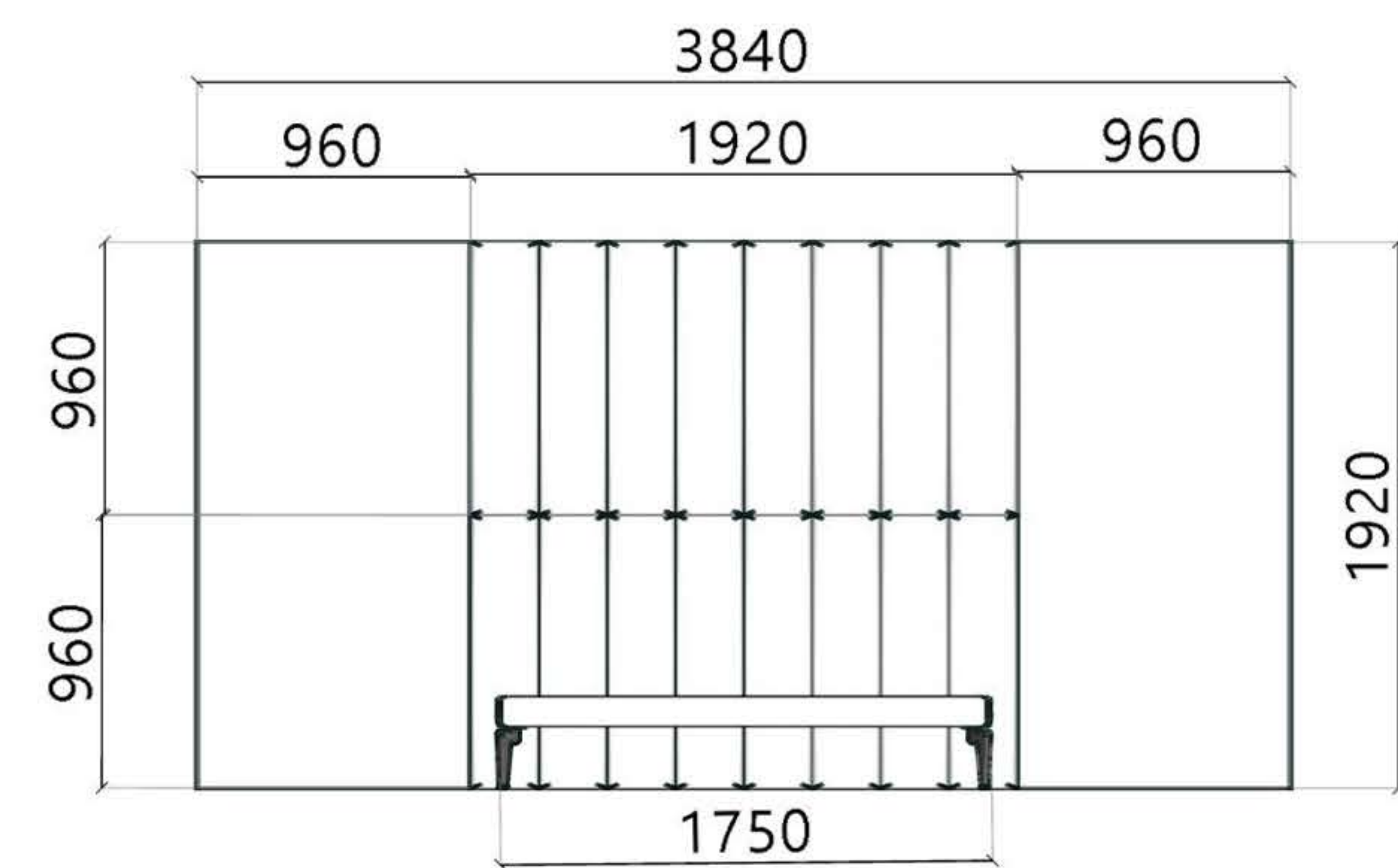





Qui e nelle pagine precedenti armadio a battente della collezione "Tutte le Notti" con ante laccate opaco fango Basic. Nell'armadio è presente un vano in rovere tabacco con pannello inclinabile per agganciarvi un tv.

Here and in the previous pages: Swing door wardrobe from the "Tutte le Notti" collection with matte lacquered mud Basic doors. Inside the wardrobe, there is a compartment in tobacco oak with a tilting panel to attach a TV.

Dettaglio vano per TV.

Detail of tv space.



Dettaglio pannello rotante.

Detail of the rotating panel.



Comò a quattro cassetti della serie Wally con struttura e facciata laccate fango opaco maniglia per l'apertura canna di fucile metallizzata.

Four-drawer dresser from the Wally series with structure and fronts lacquered in matte mud, gunmetal metallic handle for opening.





"Soffici Abbracci: Avvolgiti nel Calore di un Sonno Dolce e Accogliente"

Benvenuti in una collezione dove il comfort diventa un delicato abbraccio di morbidezza. "Soffici Abbracci" è un invito a sperimentare il calore di un sonno avvolto dalla dolcezza e dall'accoglienza. Ogni pezzo è pensato per cullarti in un abbraccio soffice di comfort, con linee morbide e materiali accoglienti che convergono per creare un ambiente notturno di puro piacere. Scoprite come "Soffici Abbracci" trasforma la vostra camera da letto in un rifugio di dolce relax. Lasciatevi avvolgere dalla morbidezza degli "Soffici Abbracci".



"Soft Embraces: Wrap Yourself in the Warmth of a Sweet and Cozy Sleep"

Welcome to a collection where comfort becomes a gentle embrace of softness. "Soft Embraces" is an invitation to experience the warmth of sleep wrapped in sweetness and hospitality. Each piece is designed to cradle you in a soft embrace of comfort, with gentle lines and inviting materials converging to create a nighttime environment of pure pleasure. Discover how "Soft Embraces" transforms your bedroom into a haven of sweet relaxation. Let yourself be enveloped by the softness of "Soft Embraces."

AMBRA

nuvole di comfort
clouds of comfort







Qui e nelle pagine precedenti: letto Ambra, testata imbottita capitonnè in velluto color fumo. Letto con cassonetto contenitore rivestito in velluto colr fumo. Da un lato comodino della serie Aurora a 3 cassetti con struttura e frontali laccati bianco opaco, dall'altro lato 2 tavolini Stefano di diversa dimensione con struttura in metallo canna di fecile e piano laccato fumo opaco.

Here and on the previous pages: Ambra bed, tufted upholstered headboard in smoke-colored velvet. Bed with a storage box covered in smoke-colored velvet. On one side, a bedside table from the Aurora series with 3 drawers, featuring a structure and fronts lacquered in matte white. On the other side, two Stefano tables of different sizes with a smoke lacquered top and a metal structure in matte gunmetal gray.

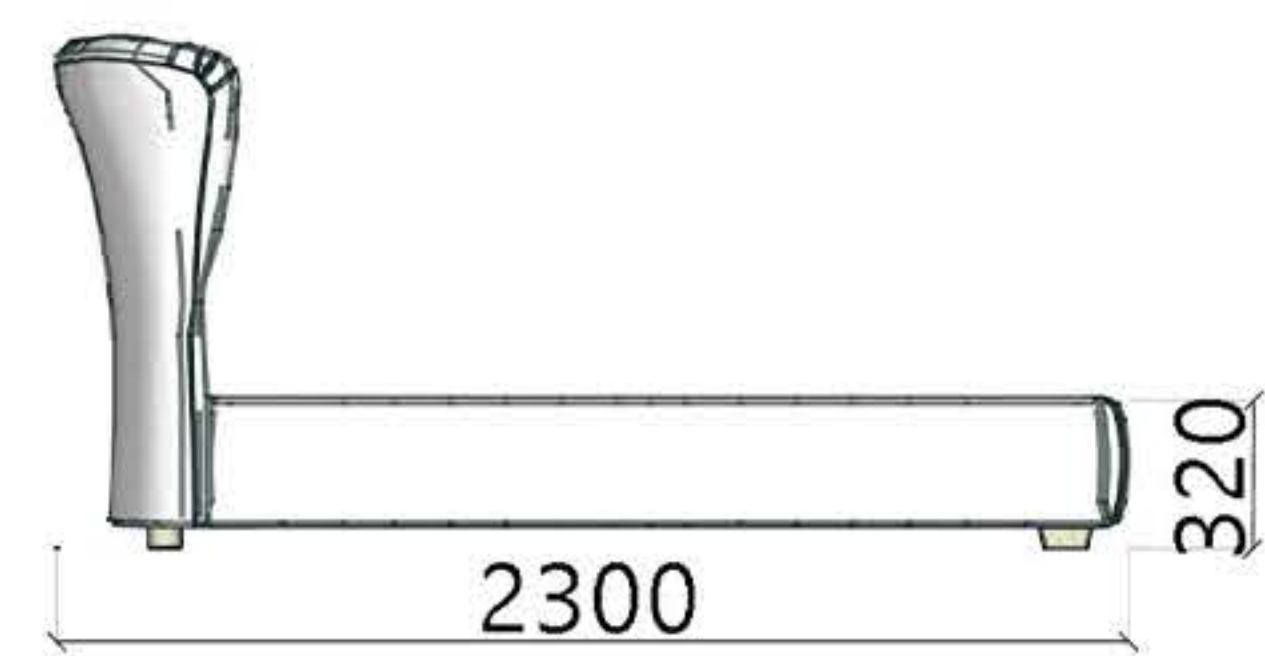
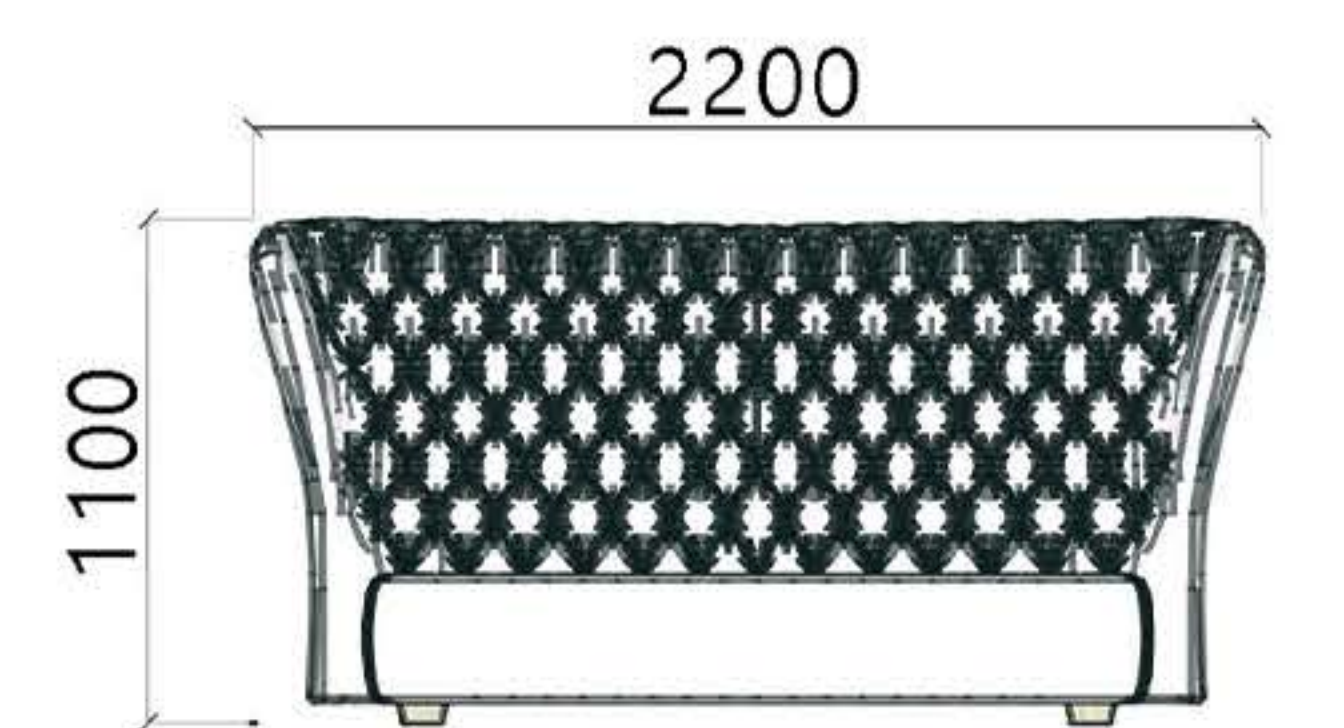





Qui e nelle pagine precedenti cabina armadio a pannelli della collezione "Tutte le Notti" con schiena laccata bianco opaco e accessori laccati grafite opaco. Chiusura della cabina con ante scorrevoli con profilo in alluminio bianco opaco e vetri trasparenti.

Here and on the previous pages: panel wardrobe from the "Tutte le Notti" collection with a matte white lacquered back and matte graphite lacquered accessories. The wardrobe is closed with sliding doors featuring a matte white aluminum profile and transparent glass.

Dettaglio tavolini Stefano

Detail of Stefano tables.



Base sospesa laccata grafite opaca realizzata con bussolotti a cassetti della serie Aliante.

Suspended base lacquered in matte graphite, made with drawer wall cabinets from the Aliante series.



Comò a quattro cassetti della serie Aurora con struttura e frontali laccati bianco opaco.

Four-drawer dresser from the Aurora series with a structure and fronts lacquered in matte white.





"Nuvole di Comfort: Sogni Avvolgenti tra Morbidezza e Relax"

Benvenuti in una collezione dove la sensazione di comfort si trasforma in soffici nuvole di serenità. "Nuvole di Comfort" è un invito a immergersi in un mondo di sogni avvolgenti, dove ogni pezzo è progettato per offrire un'esperienza di morbidezza e relax senza precedenti. Linee avvolgenti e materiali accoglienti convergono per creare un ambiente notturno che trasuda comfort senza tempo. Scoprite come "Nuvole di Comfort" rende la vostra camera da letto un luogo di riposo paradisiaco. Lasciatevi cullare dalle soffici nuvole di "Nuvole di Comfort".

"Comfort Clouds: Enveloping Dreams in Softness and Relaxation"

Welcome to a collection where the sensation of comfort transforms into soft clouds of serenity. "Comfort Clouds" is an invitation to immerse yourself in a world of embracing dreams, where each piece is designed to offer an unparalleled experience of softness and relaxation. Gentle lines and inviting materials converge to create a nighttime environment that exudes timeless comfort. Discover how "Comfort Clouds" turns your bedroom into a haven of heavenly rest. Let yourself be cradled by the soft clouds of "Comfort Clouds."



VELA

comfort contemporaneo
contemporary comfort







Qui e nelle pagine precedenti: letto Vela, testata in legno curva in rovere grigio. Letto con cassonetto contenitore rientrante e fascia giroletto in rovere grigio. Comodini della serie Wally a un cassetto con struttura laccata perla opaco e facciate in rovere grigio.

Here and on the previous pages: Vela bed, curved wooden headboard in gray oak. Bed with a recessed storage box and bed frame border in gray oak. Wally bedside tables with one drawer, featuring a lacquered matte pearl structure and fronts in gray oak.

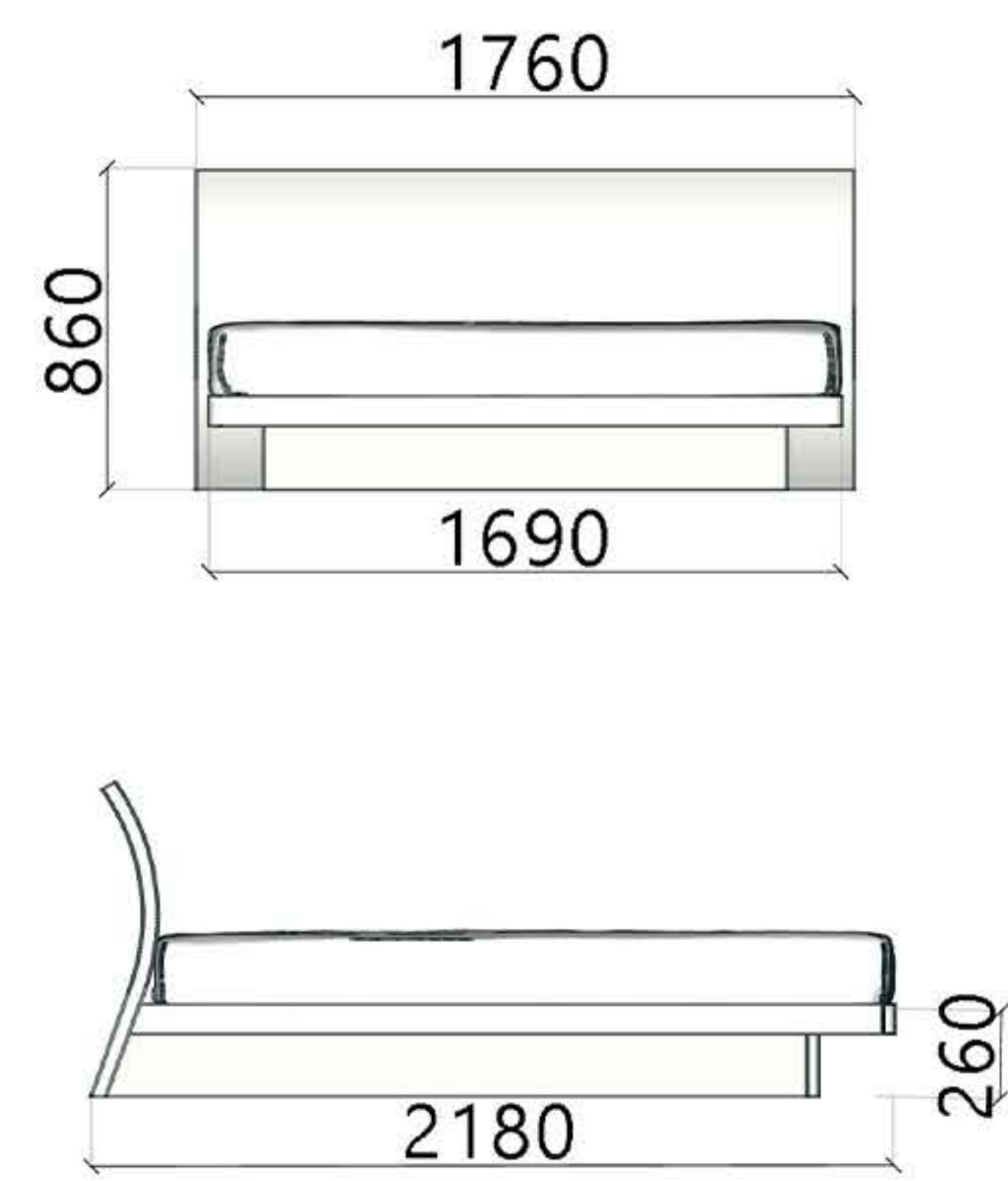





Qui e nelle pagine precedenti cabina armadio a pannelli della collezione "Tutte le Notti" con schiene laccate perla opaco e accessori laccati ferro opaco. Due armadi con ante Plumb in rovere grigiofungono da chiusura per la cabina armadio. Le ante a battente si alternano con ante a soffietto che nascondono l'accesso.

Here and on the previous pages: panel wardrobe from the "Tutte le Notti" collection with matte pearl lacquered backs and matte iron lacquered accessories. Two wardrobes with Plumb doors in gray oak act as a closure for the wardrobe. Swing doors alternate with folding doors that conceal the access.

Dettaglio ante Plumb con maniglia incassata.

Detail of Plumb doors with recessed handle.





Comò a tre cassetti sollevati della serie Wally.
Struttura laccato perla opaco facciata in rovere grigio.

*Three-drawer raised dresser from the Wally series.
Matte pearl lacquered structure with a front in gray oak.*





"Comfort Contemporaneo: Un'Esperienza di Benessere Moderno"

Benvenuti in una collezione dove il comfort si fonde con lo stile moderno. "Comfort Contemporaneo" è il cuore di ogni pezzo progettato per abbracciare il tuo spazio notturno con lusso e praticità. Linee pulite e materiali accoglienti convergono per creare un ambiente notturno che trasuda eleganza senza sforzo. Scoprite come questa collezione trasforma la vostra camera da letto in uno spazio di puro benessere e raffinatezza. Lasciatevi avvolgere dal comfort senza tempo di "Comfort Contemporaneo".



"Contemporary Comfort: A Modern Wellness Experience"

Welcome to a collection where comfort merges with modern style. "Contemporary Comfort" is the heart of each piece designed to embrace your nighttime space with luxury and practicality. Clean lines and inviting materials converge to create a nighttime environment that exudes effortless elegance. Discover how this collection transforms your bedroom into a space of pure well-being and sophistication. Let yourself be enveloped by the timeless comfort of "Contemporary Comfort."

INSIDE

energia creativa
creative energy







Qui e nelle pagine precedenti: letto Inside, testata in legno laccata visone opaco con pannello inserto in rovere sbiancato. Letto con cassettoni nella parte inferiore rientrante, struttura letto in rovere sbiancato. Comodini della serie Aliante sospeso con struttura e frontali in rovere sbiancato.

Here and on the previous pages: Inside bed, wooden headboard lacquered in matte mink with an inset panel in bleached oak. Bed with recessed drawers at the bottom, bed frame structure in bleached oak. Suspended bedside tables from the Aliante series with a structure and fronts in bleached oak.

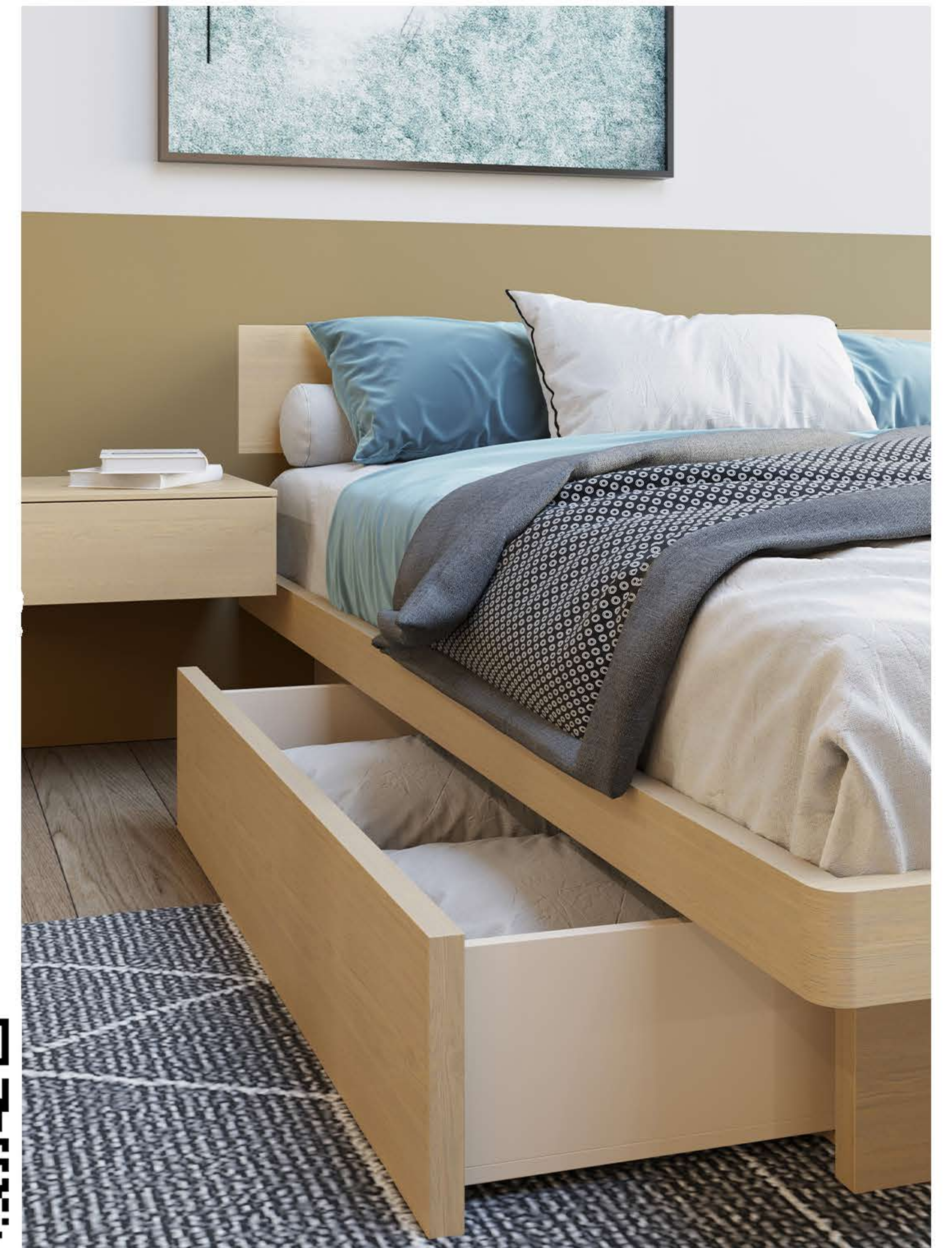
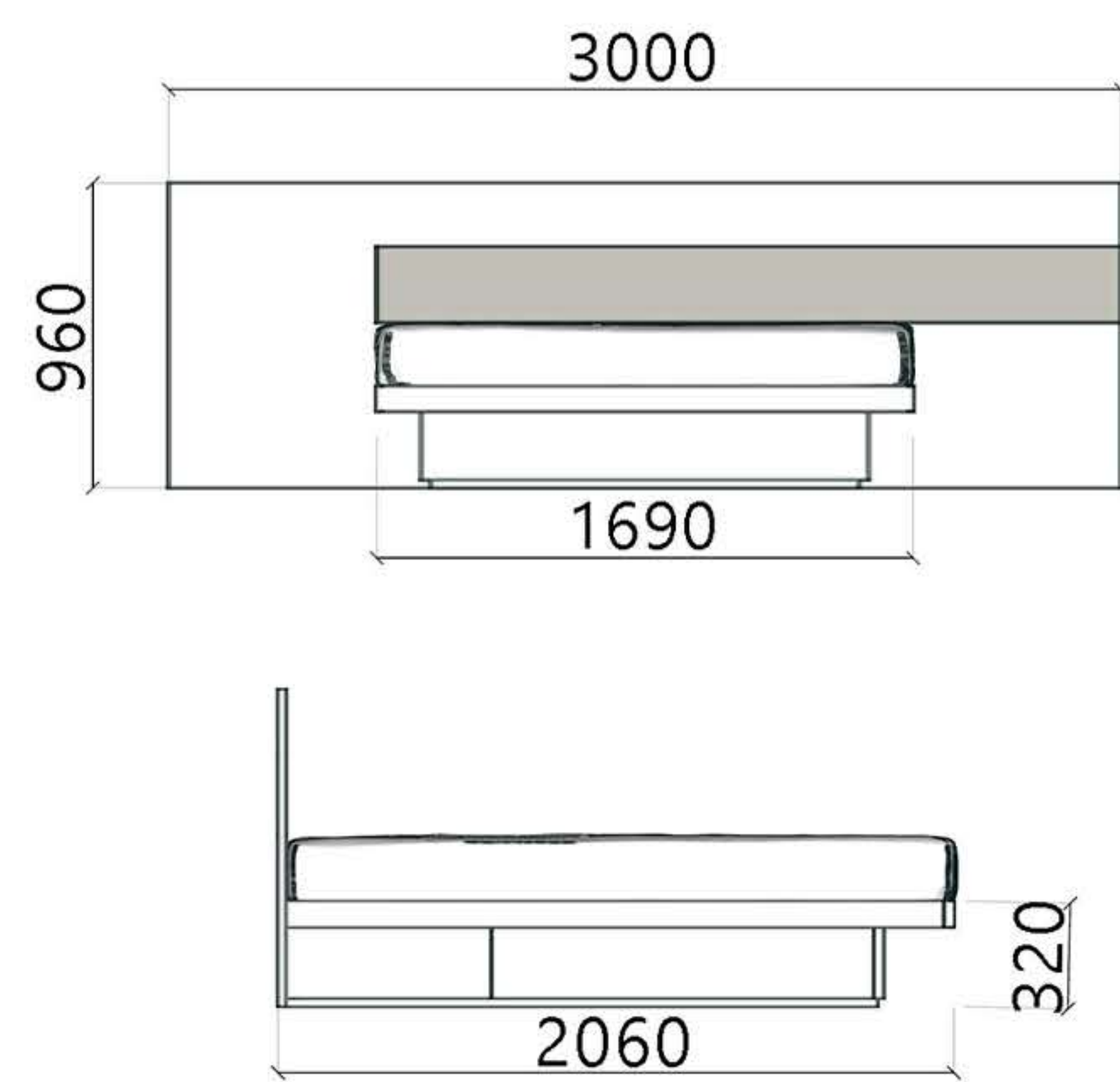





Qui e nelle pagine precedenti armadio a battente della collezione "Tutte le Notti" con ante Basic e ante con maniglia a tutt'altezza Level laccate visone opaco. Nella parte centrale vano tv creato utilizzando bussolotti della serie Orizzonte in rovere sbiancato.

Here and on the previous pages: swing door wardrobe from the "Tutte le Notti" collection with Basic doors and Level full-height handle doors, all lacquered in matte milk. In the central part, a TV compartment is created using wall cabinets from the Orizzonte series in bleached oak.

Liste divisorie Slates in rovere sbiancato per creare divisioni vedo non-vedo all'interno di un locale. Le liste vengono posizionate con ferramenta invisibile da pavimento a soffitto.

Dividing slats "Slates" in bleached oak to create see-through partitions within a room. The slats are positioned with invisible hardware from the floor to the ceiling.

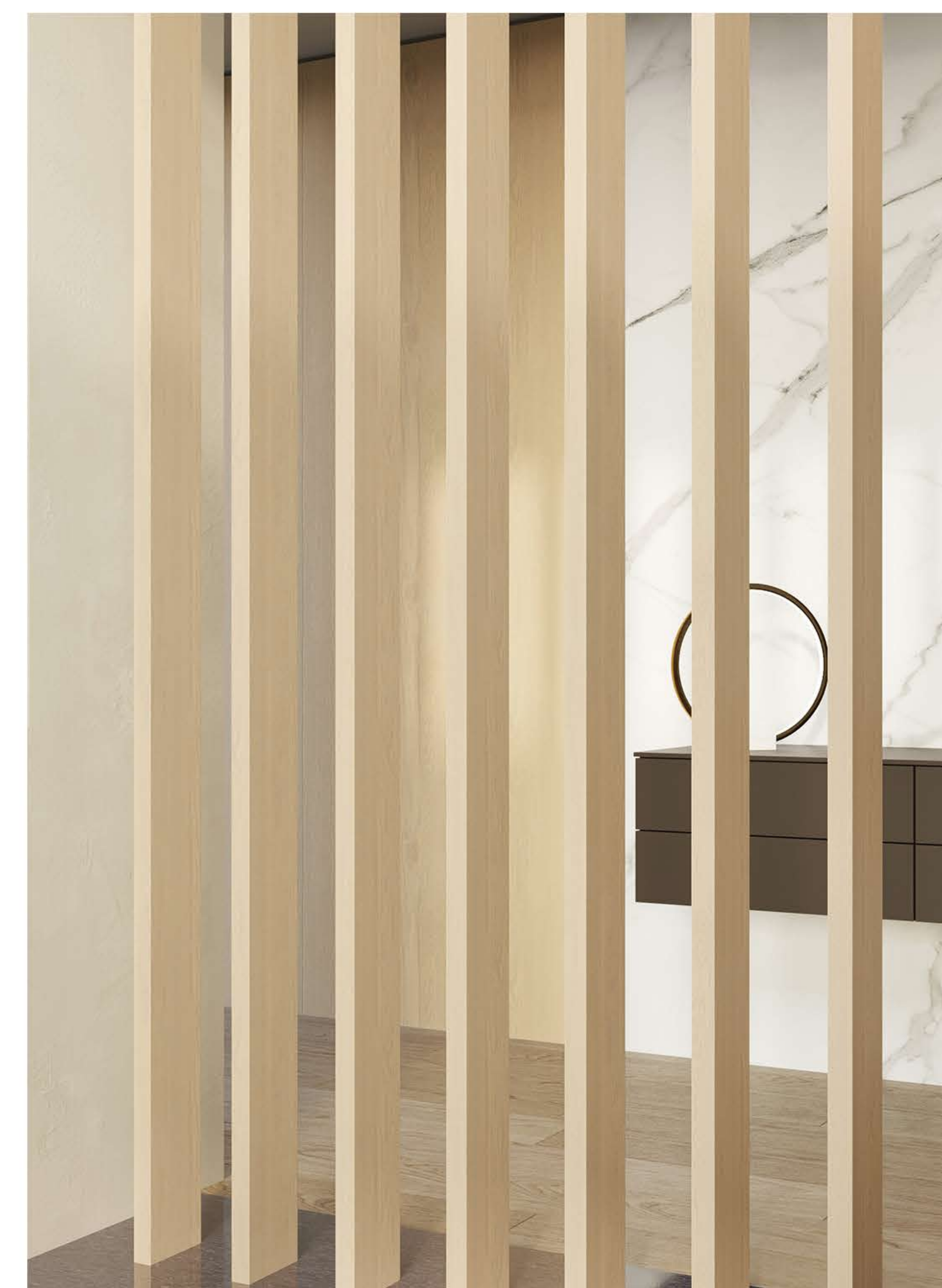



Area beauty creata con mobili della Serie Aliante sospesi laccati fango opaco. Specchiera Framed rotonda con cornice laccata fango opaco. Sedia Artù in rovere sbiancato con seduta in ecopelle. Pannellatura a muro e fasce divisorie in rovere sbiancato con inserto di pannello rivestito in gres porcellanato statuario.

Beauty area created with suspended furniture from the Aliante series lacquered in matte mud. Framed round mirror with a matte mud lacquered frame. Artù chair in bleached oak with a seat in faux leather. Wall paneling and dividing strips in bleached oak with an insert of statuary porcelain stoneware-covered panel.





"Energia Creativa: Illumina la Tua Notte con un Design Innovativo"

Benvenuti in una collezione dove l'ispirazione si traduce in design e l'innovazione si fonde con l'arte. "Energia Creativa" è l'espressione di uno stile che sprigiona vitalità, dove ogni pezzo è una testimonianza di idee audaci e dettagli raffinati. Linee dinamiche e materiali innovativi convergono per creare un ambiente notturno che incarna la forza dell'energia creativa. Scoprite come questa collezione trasforma la vostra camera da letto in uno spazio vibrante di ispirazione e design distintivo. Lasciate fluire l'energia creativa con "Energia Creativa".

"Creative Energy: Illuminate Your Night with Innovative Design"

Welcome to a collection where inspiration translates into design, and innovation merges with art. "Creative Energy" is the expression of a style that exudes vitality, where each piece is a testament to bold ideas and refined details. Dynamic lines and innovative materials converge to create a nighttime environment that embodies the strength of creative energy. Discover how this collection transforms your bedroom into a vibrant space of inspiration and distinctive design. Let the creative energy flow with "Creative Energy."



DATI TECNICI

gruppo ALIANTE	pag. 274
gruppo ASTON	pag. 276
gruppo AURORA	pag. 278
gruppo NOAH	pag. 280
gruppo STEFANO	pag. 282
gruppo VALENTINA	pag. 284
gruppo WALLY	pag. 286
gruppo WIND	pag. 288
FINITURE	pag. 290

ALIANTE - ALIANTE RITMUS



1 comodino a 1 cassetto
L. 480 H. 185 P. 440 mm

2 comodino a 1 cassetto
L. 640 H. 185 P. 440 mm

3 comodino a 2 cassetti
L. 480 H. 345 P. 440 mm

4 comodino a 2 cassetti
L. 640 H. 345 P. 440 mm

5 comò a 4 cassetti
L. 1280 H. 780 P. 560 mm

6 comò a 4 cassetti e cassettone
L. 1280 H. 780 P. 560 mm

7 settimano a 6 cassetti
L. 640 H. 1260 P. 560 mm

8 comodino a 1 cassetto
L. 480 H. 310 P. 440 mm

9 comodino a 1 cassetto
L. 640 H. 310 P. 440 mm

10 comodino a 2 cassetti
L. 480 H. 470 P. 440 mm

11 comodino a 2 cassetti
L. 640 H. 470 P. 440 mm

12 comò a 4 cassetti
L. 1280 H. 905 P. 560 mm

13 comò a 4 cassetti e cassettone
L. 1280 H. 905 P. 560 mm

14 settimano a 6 cassetti
L. 640 H. 1385 P. 560 mm

ASTON



1 comodino a 2 cassetti
L. 650 H.400 P. 450 mm

2 comodino a 3 cassetti
L. 450 H.520 P. 450 mm

3 comò a 3 cassetti
L. 1320 H.670 P. 570 mm

4 comodino a 2 cassetti con piedi
L. 650 H.540 P. 450 mm

5 comodino a 3 cassetti con piedi
L. 450 H.660 P. 450 mm

6 comò a 3 cassetti con piedi
L. 1320 H.810 P. 570 mm

AURORA

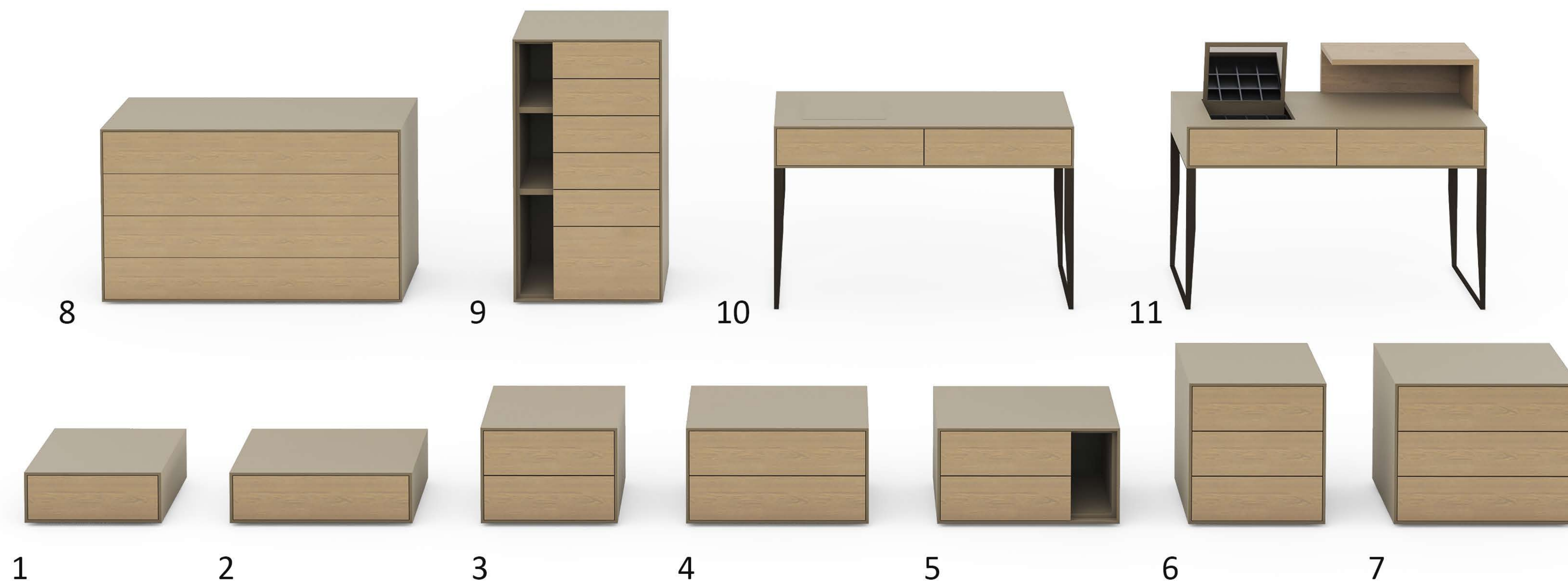

1 comodino a 1 cassetto
L. 480 H.185 P. 440 mm

2 comodino a 1 cassetto
L. 640 H.185 P. 440 mm

3 comodino a 2 cassetti
L. 480 H.345 P. 440 mm

4 comodino a 2 cassetti
L. 640 H.345 P. 440 mm

5 comodino a 2 cassetti e vano
L. 640 H.345 P. 440 mm

6 comodino a 3 cassetti
L. 480 H.525 P. 440 mm

7 comodino a 3 cassetti
L. 640 H.525 P. 440 mm

8 comò a 4 cassetti
L. 1290 H.775 P. 560 mm

9 settimano a 6 cassetti e vano
L. 640 H.1145 P. 440 mm

10 toeletta a 1 cassetto
L. 1280 H.760 P. 620 mm

11 toeletta a 1 cassetto con alzatina
L. 1280 H.870 P. 620 mm

NOAH

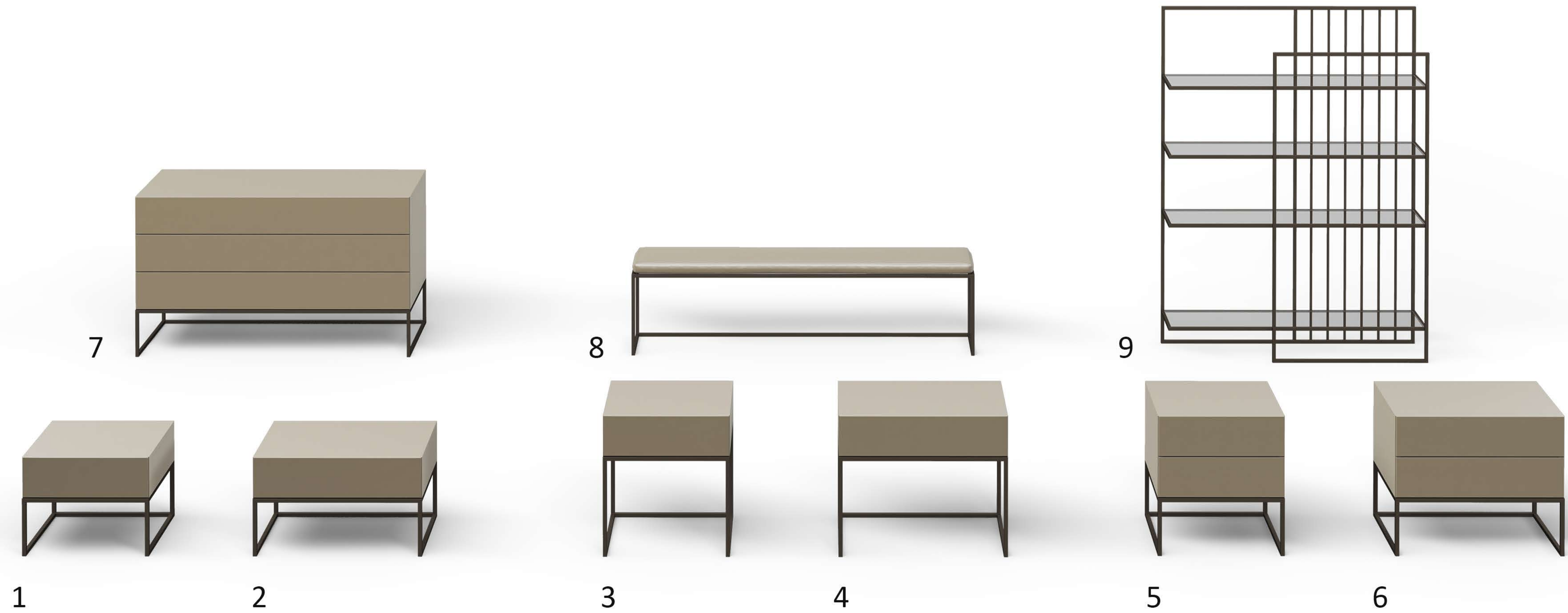

1 comodino a 1 cassetto
L. 480 H.380 P. 425 mm

2 comodino a 1 cassetto
L. 640 H.380 P. 425 mm

3 comodino a 1 cassetto
L. 480 H.540 P. 425 mm

4 comodino a 1 cassetto
L. 640 H.540 P. 425 mm

5 comodino a 2 cassetti
L. 480 H.540 P. 425 mm

6 comodino a 2 cassetti
L. 640 H.540 P. 425 mm

7 comò a 3 cassetti
L. 1280 H.760 P. 545 mm

8 panchetta scendiletto
L. 1600 H.380 P. 410 mm

9 libreria divisoria
L. 1200 H.1600 P. 320 mm

STEFANO - TAVOLINI - POUF



1 comodino a 1 cassetto
L. 600 H.480 P. 560 mm

2 comodino a 1 cassetto
L. 480 H.580 P. 520 mm

3 comò a 2 cassetti
L. 1280 H.750 P. 560 mm

4 tavolino Stefano alto
L. 400 H.470 P. 400 mm

5 tavolino Stefano basso
L. 500 H.370 P. 500 mm

6 tavolino Trip
L. 550 H.520 P. 550 mm

7 tavolino Tulip
L. 550 H.500 P. 550 mm

8 pouf Dado
L. 460 H.460 P. 460 mm

9 pouf Cilindro
L. 460 H.460 P. 460 mm

10 pouf Pave
L. 1480 H.460 P. 460 mm

VALENTINA - SPECCHIERE



2



1

1 comodino a 2 cassetti
L. 510 H. 410 P. 480 mm

2 comò a 3 cassetti
L. 1310 H. 720 P. 600 mm



5

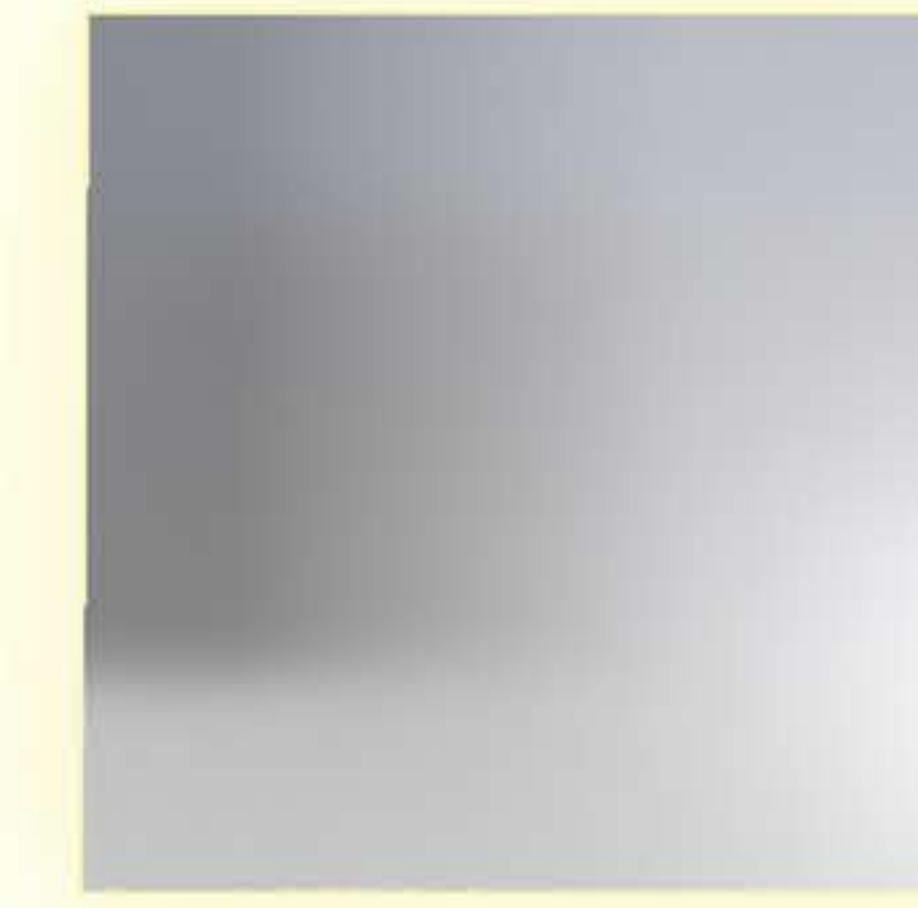

6



3

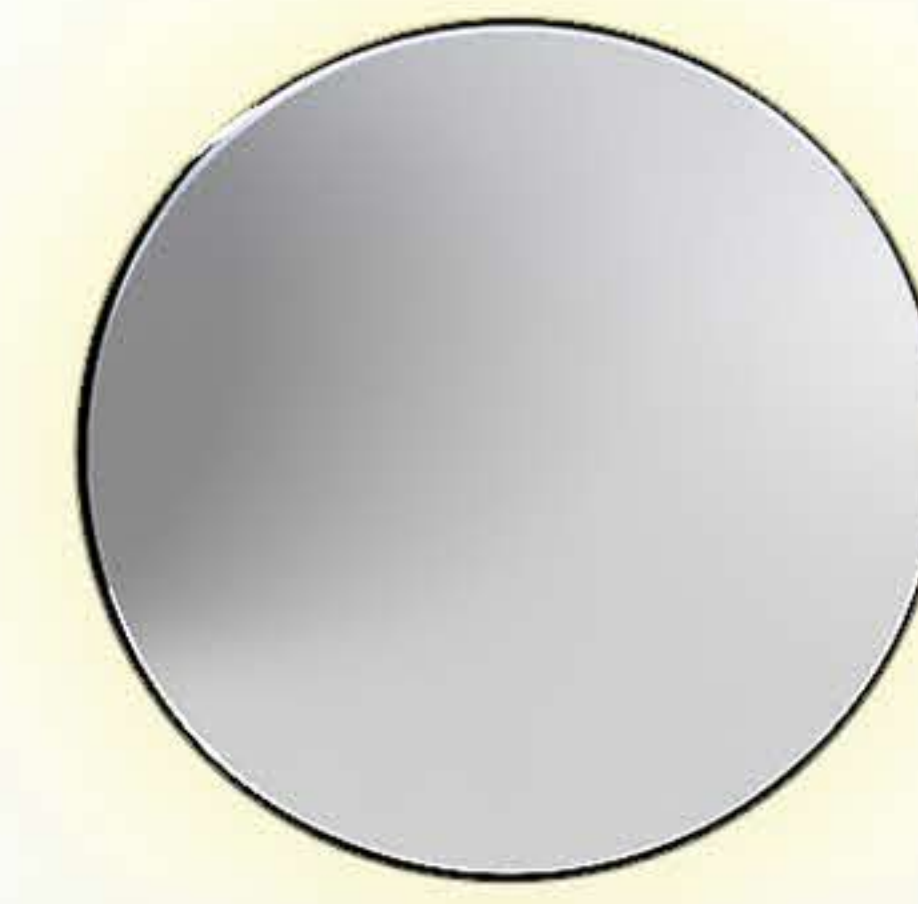

4

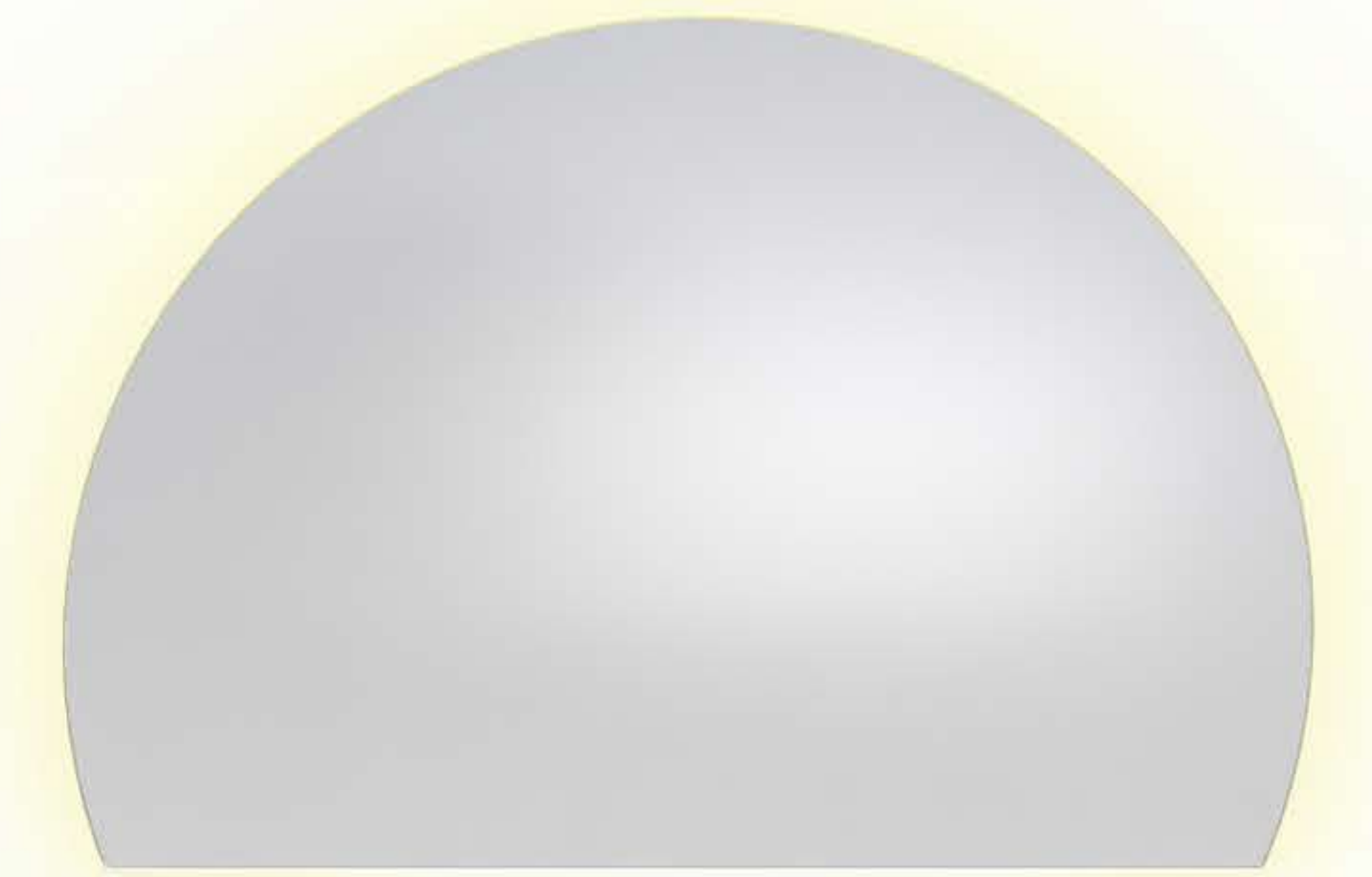

7

3 specchiera Frame tonda
L. 1000 H. 1000 P. 35 mm

4 specchiera Naked tonda
L. 800 H. 800 P. 35 mm

5 specchiera Frame quadra
L. 1000 H. 1000 P. 35 mm

6 specchiera Naked quadra
L. 800 H. 800 P. 35 mm

7 specchiera mezzaluna
L. 1500 H. 1000 P. 35 mm

WALLY



1 comodino a 2 cassetti
L. 530 H.410 P. 470 mm

2 comodino a 2 cassetti
L. 690 H.410 P. 470 mm

3 comò a 4 cassetti
L. 1330 H.790 P. 590 mm

4 comodino a 1 cassetto
L. 530 H.410 P. 470 mm

5 comodino a 1 cassetto
L. 690 H.410 P. 470 mm

6 comò a 3 cassetti
L. 1330 H.790 P. 590 mm

ALIANTE SOSPESO - WIND

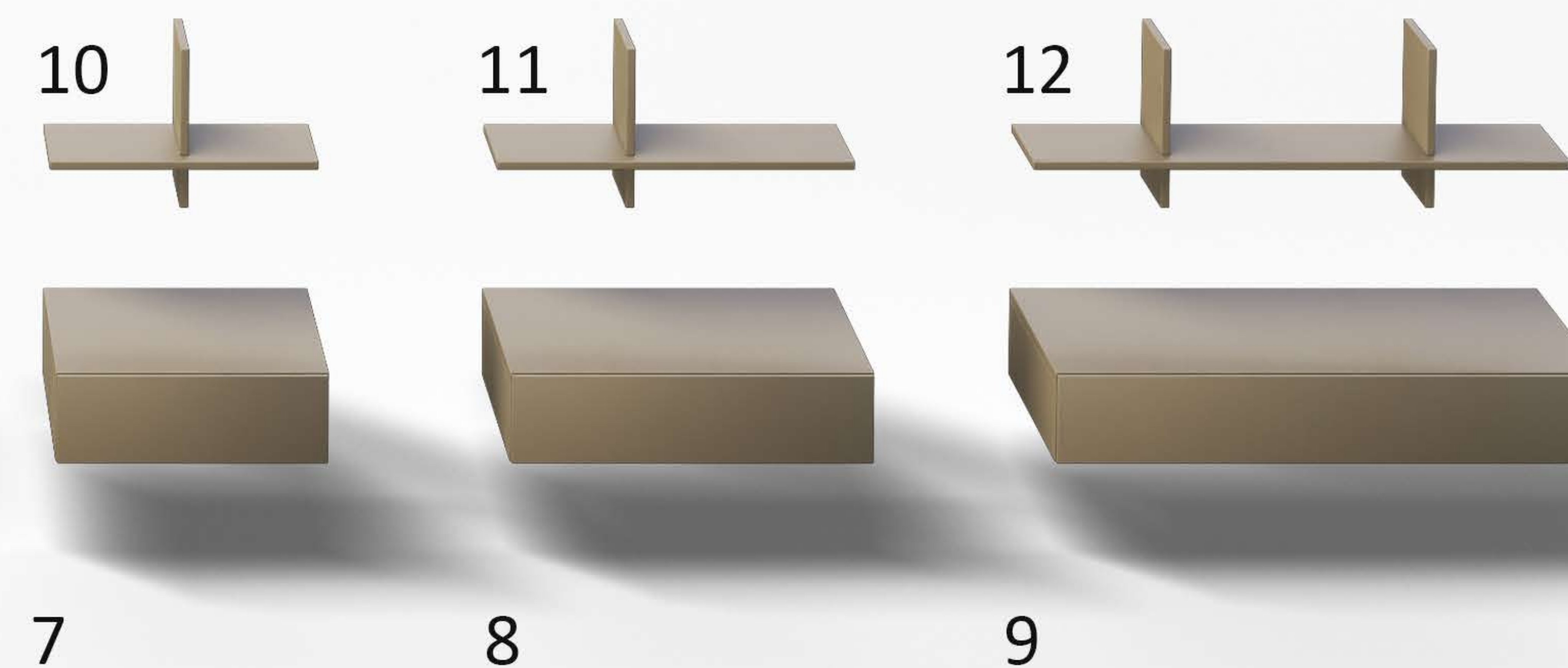
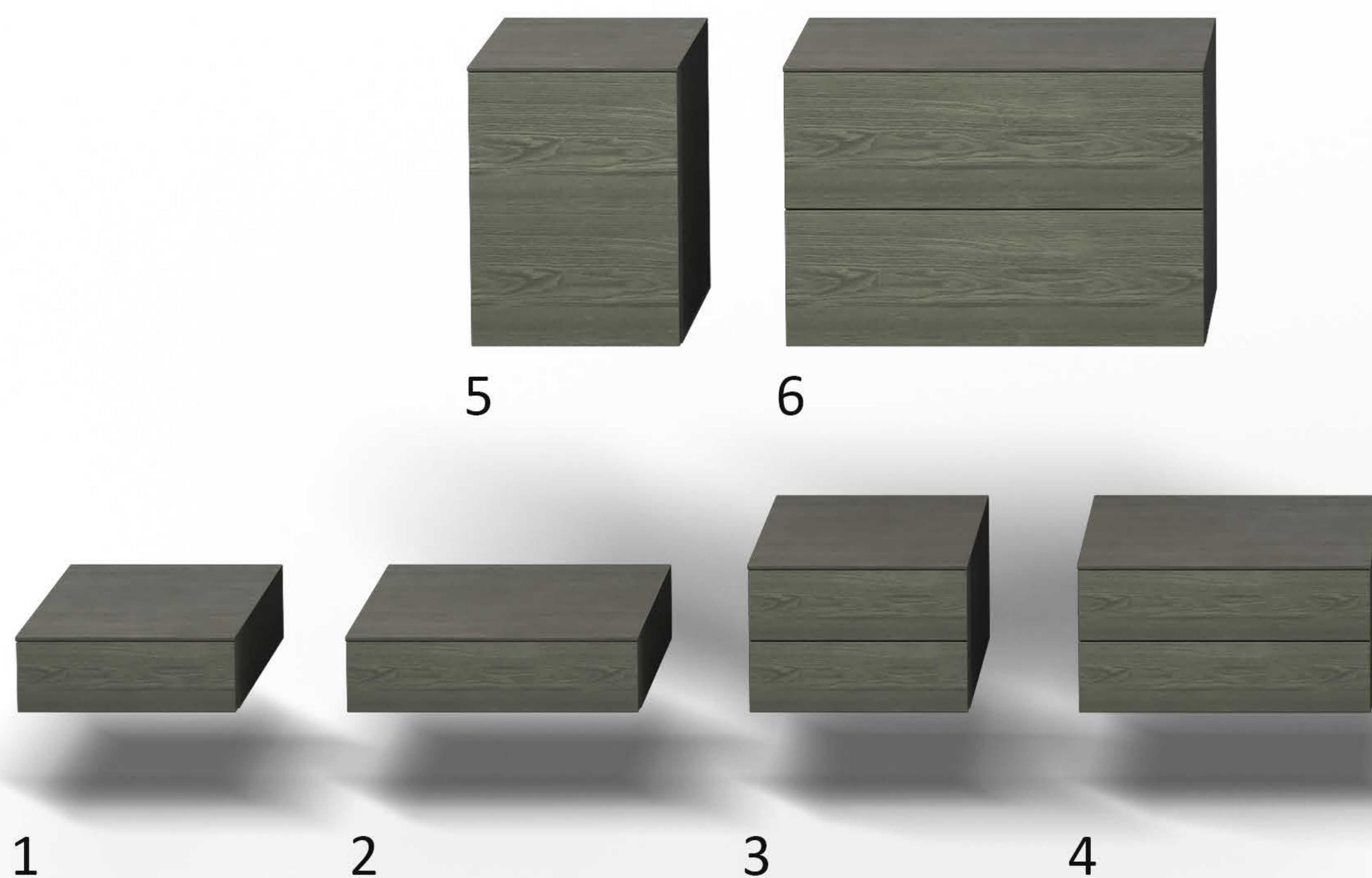

1 comodino a 1 cassetto
L. 480 H. 160 P. 440 mm

2 comodino a 1 cassetto
L. 640 H. 160 P. 440 mm

3 comodino a 2 cassetti
L. 480 H. 320 P. 440 mm

4 comodino a 2 cassetti
L. 640 H. 320 P. 440 mm

5 elemento a 1 anta
L. 480 H. 640 P. 440 mm

6 elemento a 2 cassettoni
L. 960 H. 640 P. 440 mm

7 comodino a 1 cassetto
L. 480 H. 160 P. 425 mm

8 comodino a 1 cassetto
L. 640 H. 160 P. 425 mm

9 comodino a 1 cassetto
L. 960 H. 160 P. 425 mm

10 mensola a croce
L. 480 H. 240 P. 200 mm

11 mensola a croce
L. 640 H. 240 P. 200 mm

12 mensola a croce
L. 960 H. 240 P. 200 mm

ESSENZA ROVERE

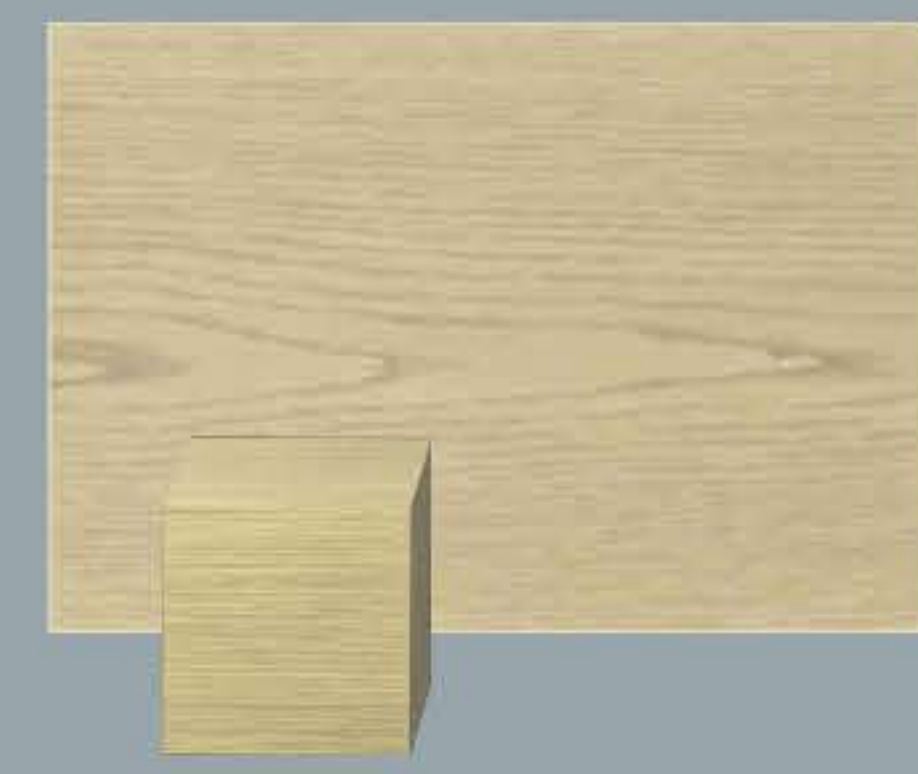

sbiancato/bleached

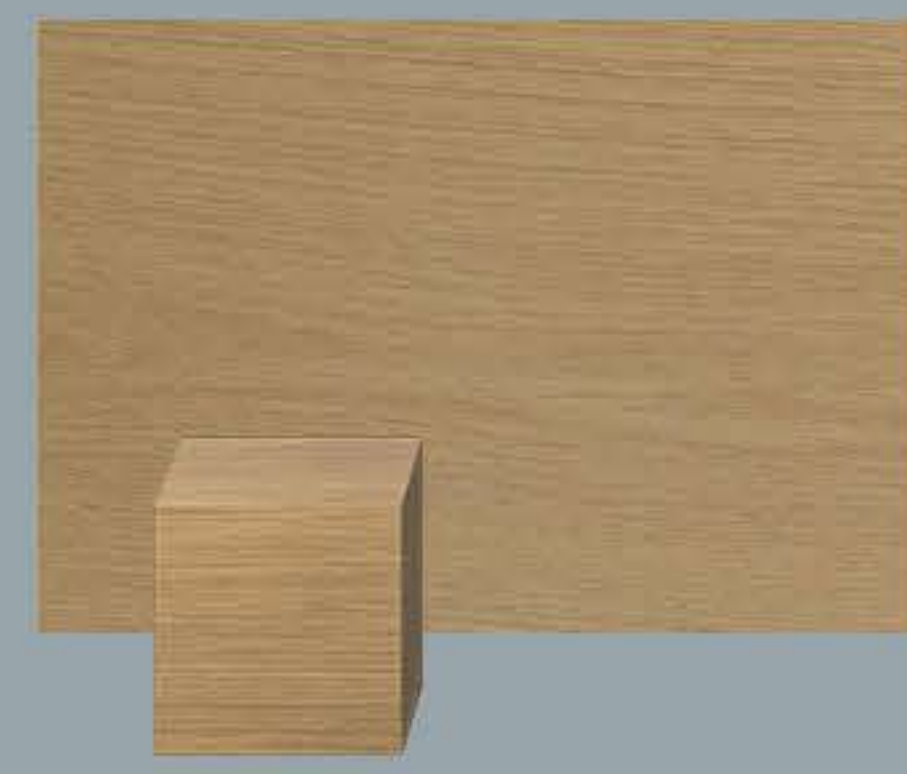

sahara/sahara



tabacco/tobacco



miele/honey

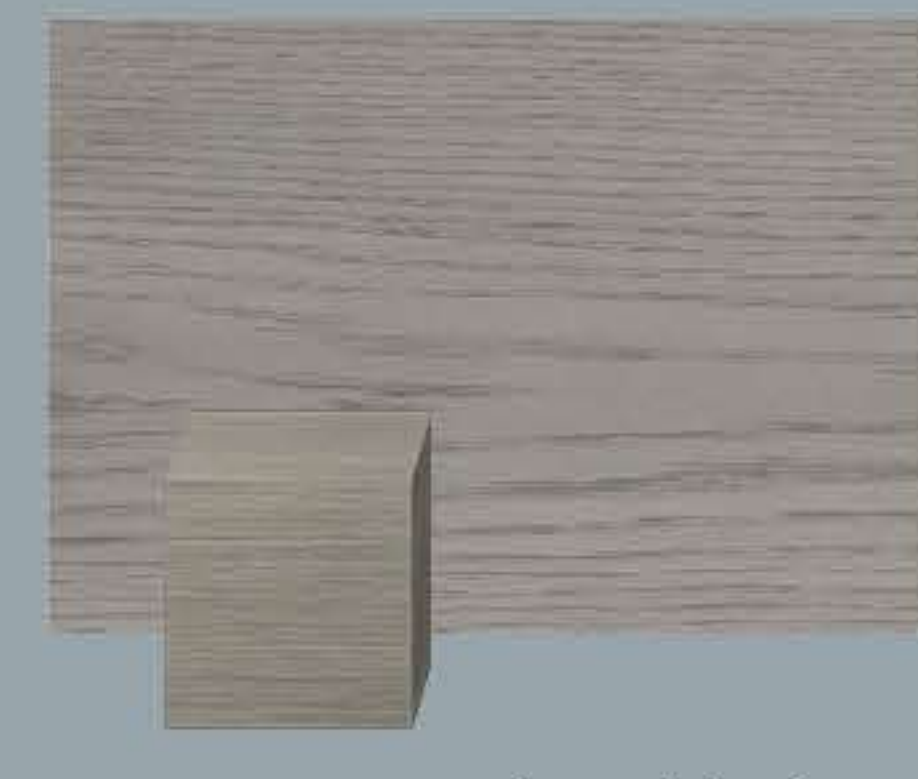

polvere/dusty

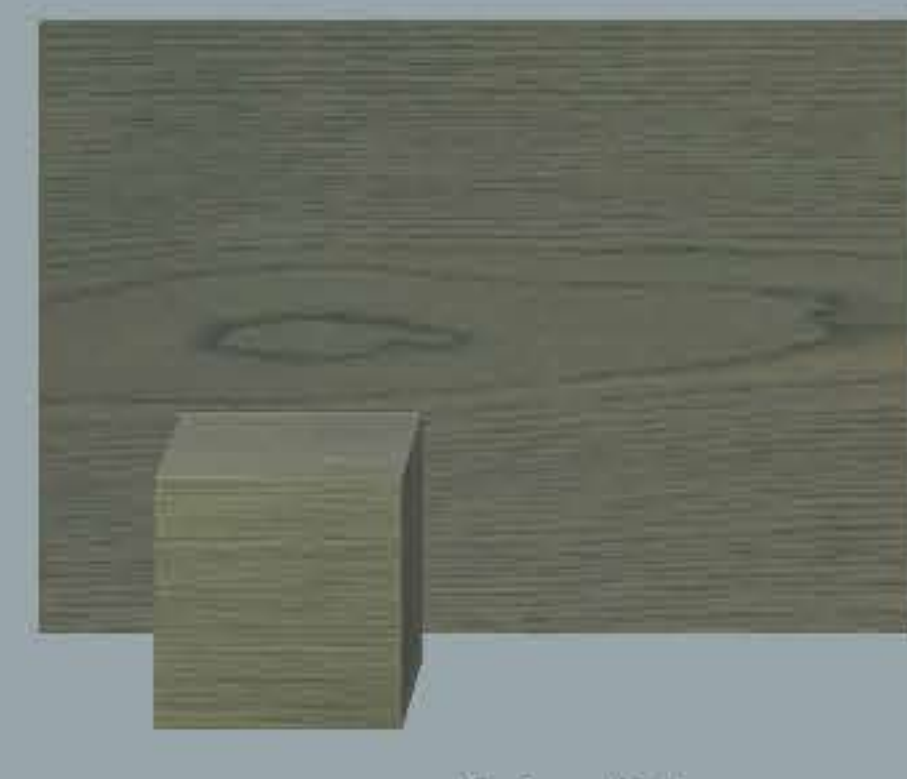

pietra/stone

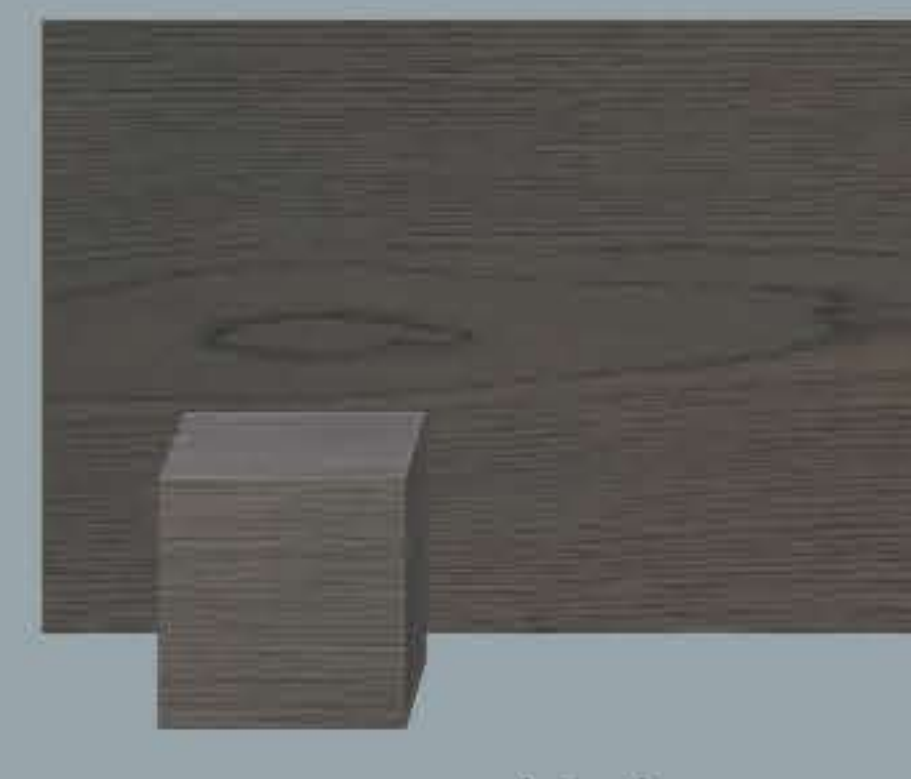

grigio/gray

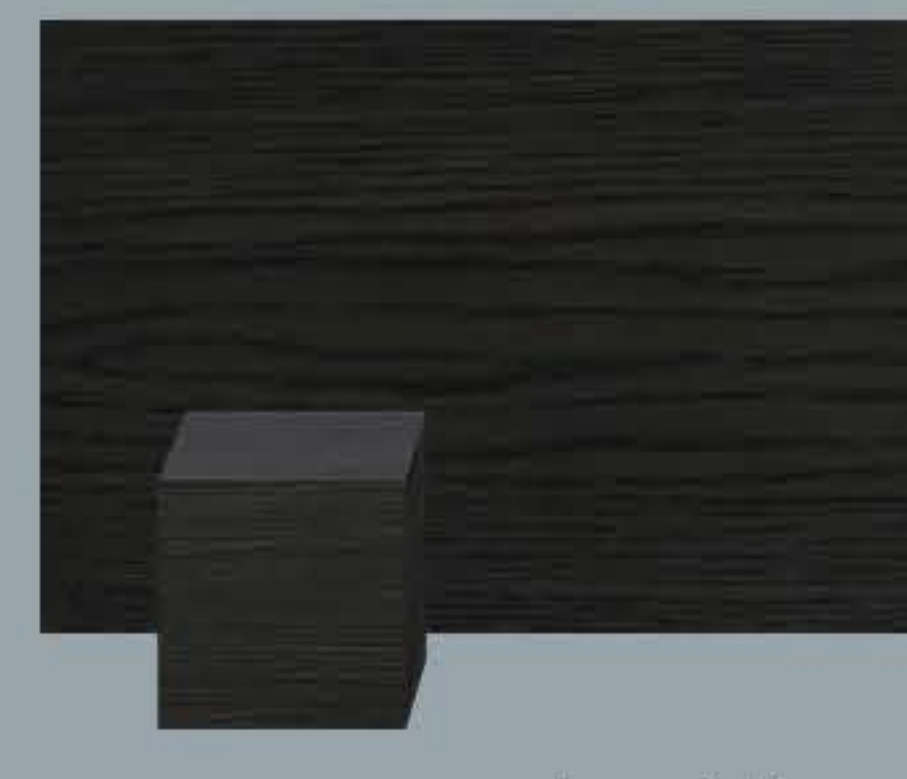

carbone/charcoal

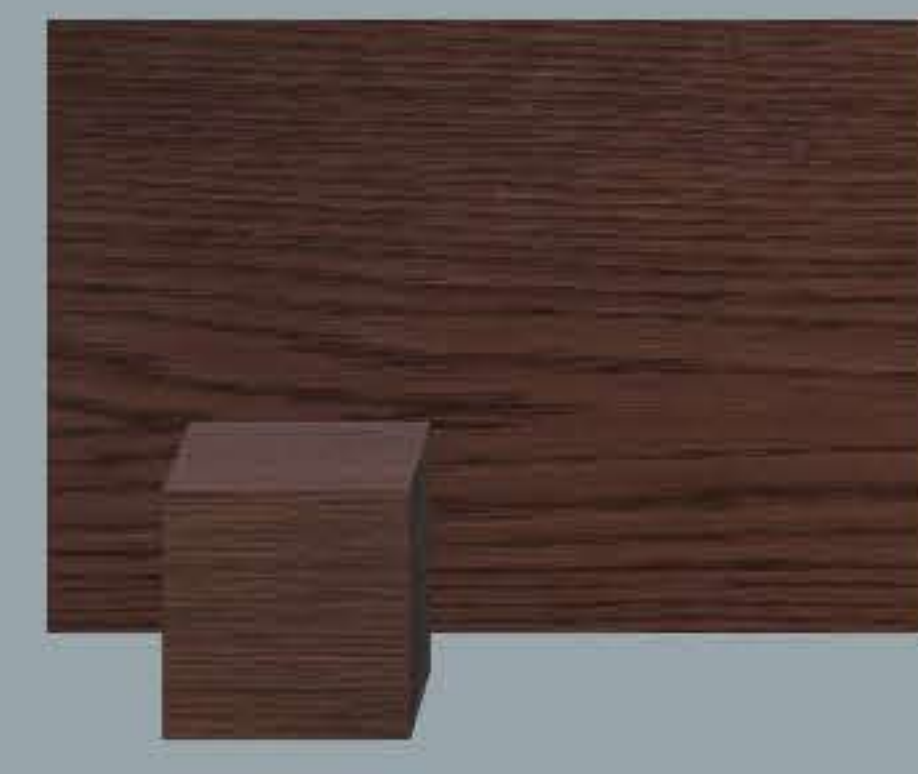

cotto/baked



bruciato/burnt



moro/dark brown

LACCATI OPACO LISCI e GOFFRATI

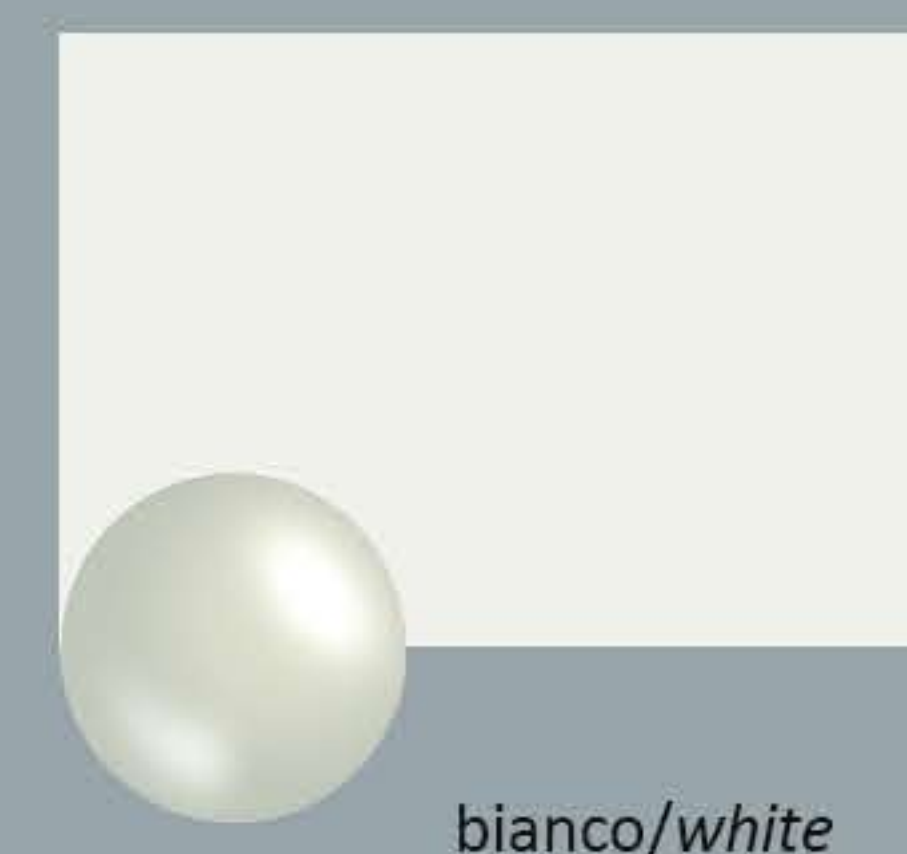

bianco/white

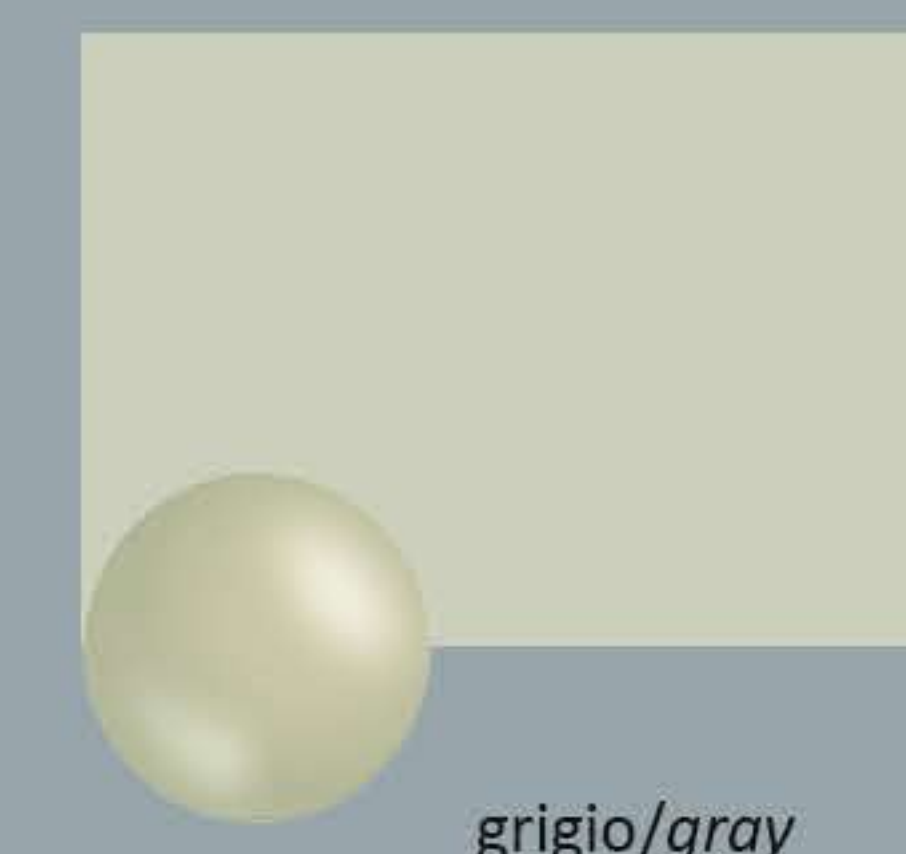

grigio/gray

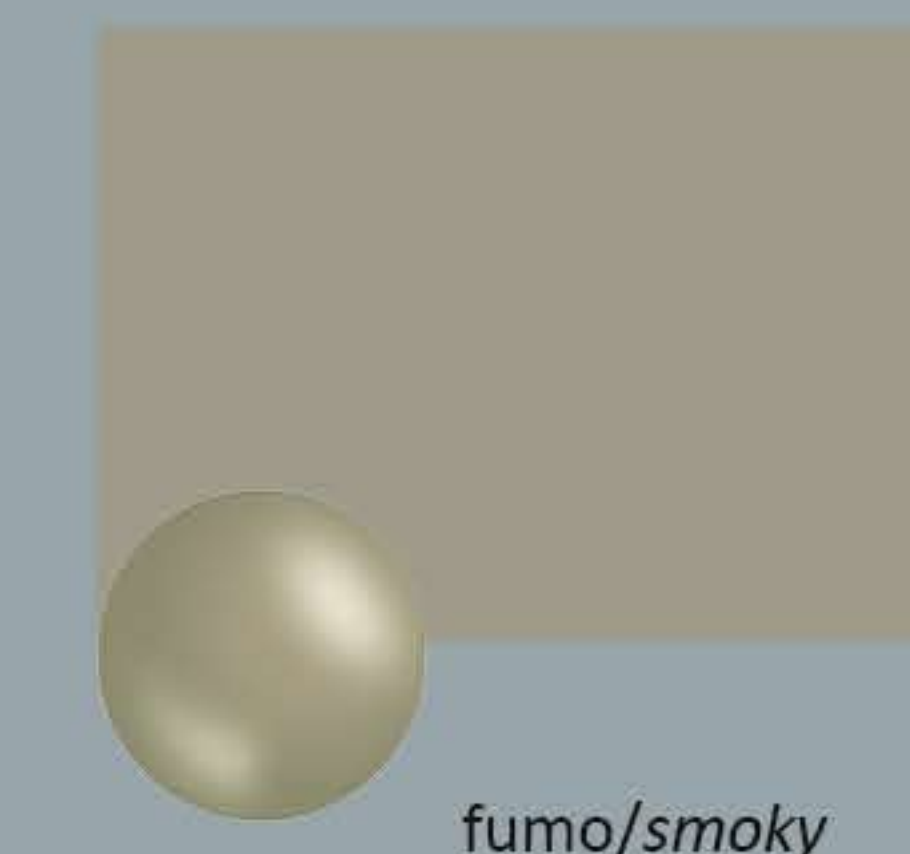

fumo/smoky

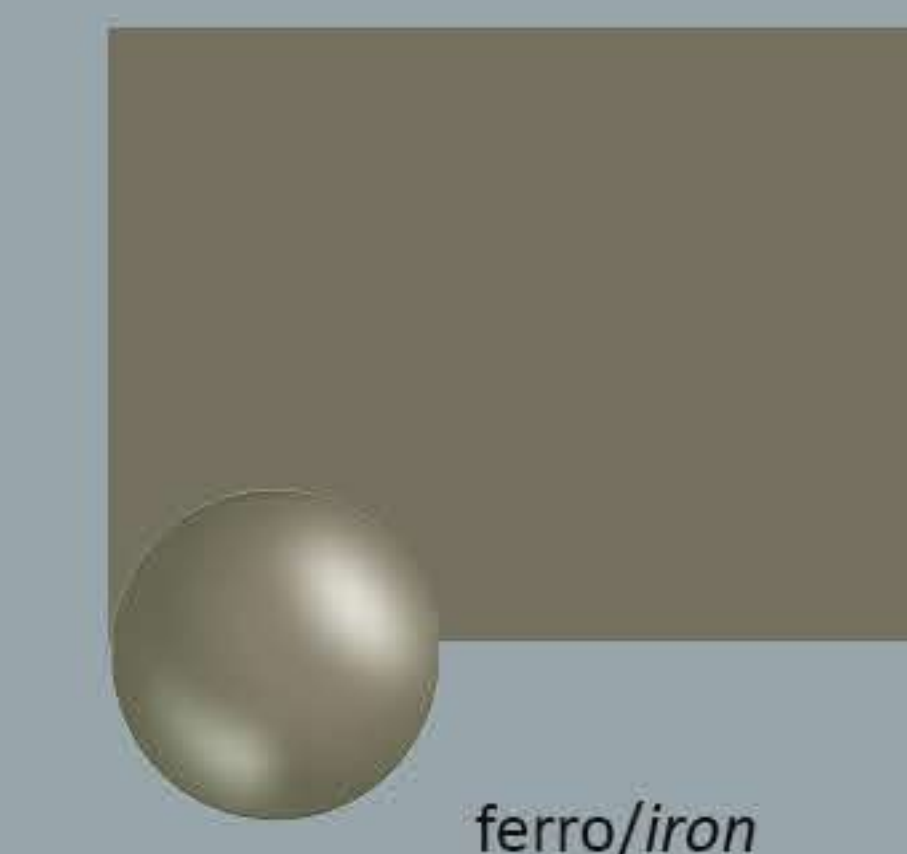

ferro/iron

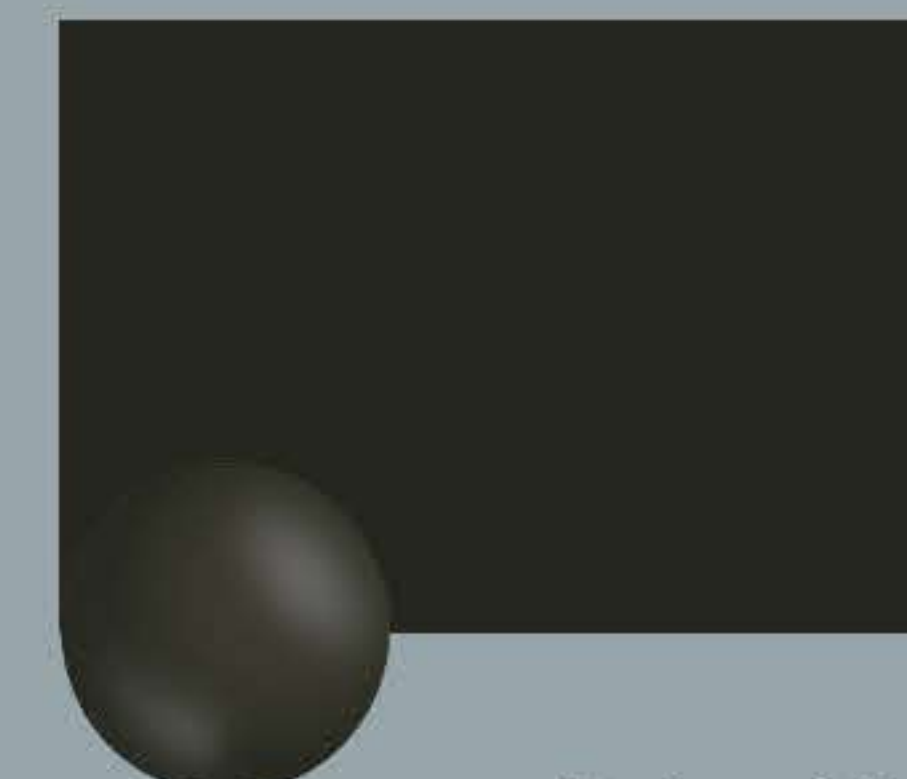

grafite/graphite

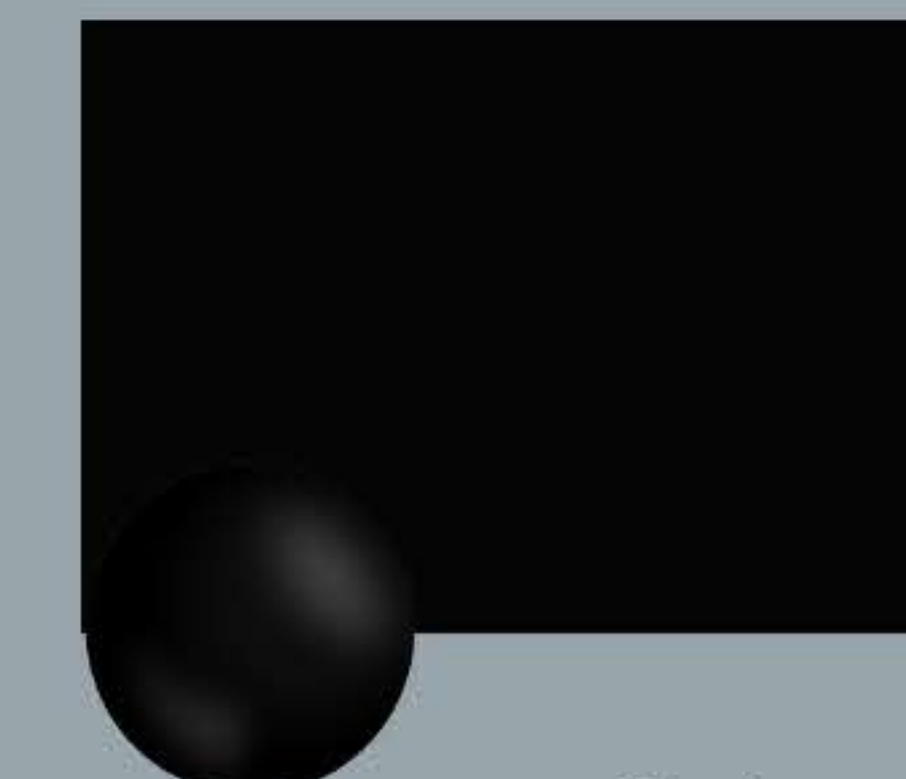

nero/black

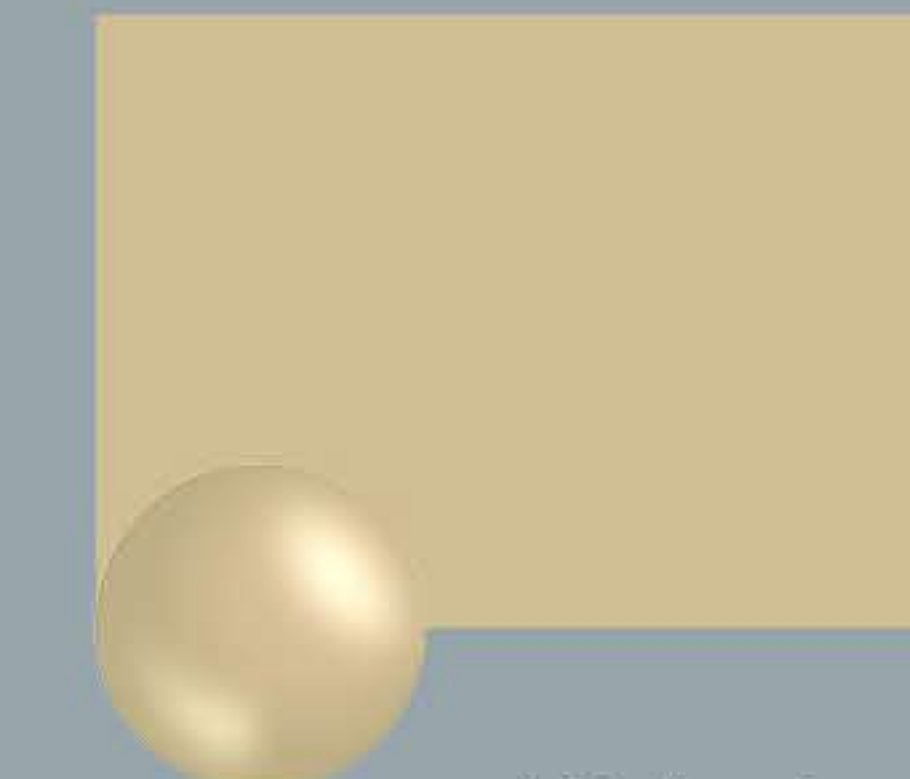

sabbia/sand

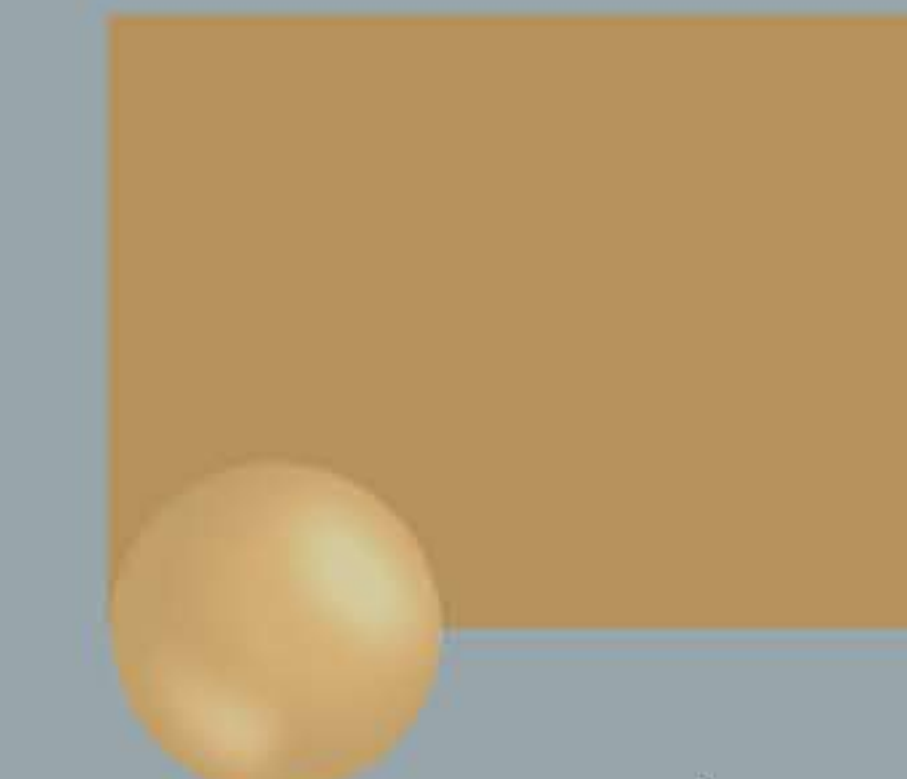

cognac/cognac

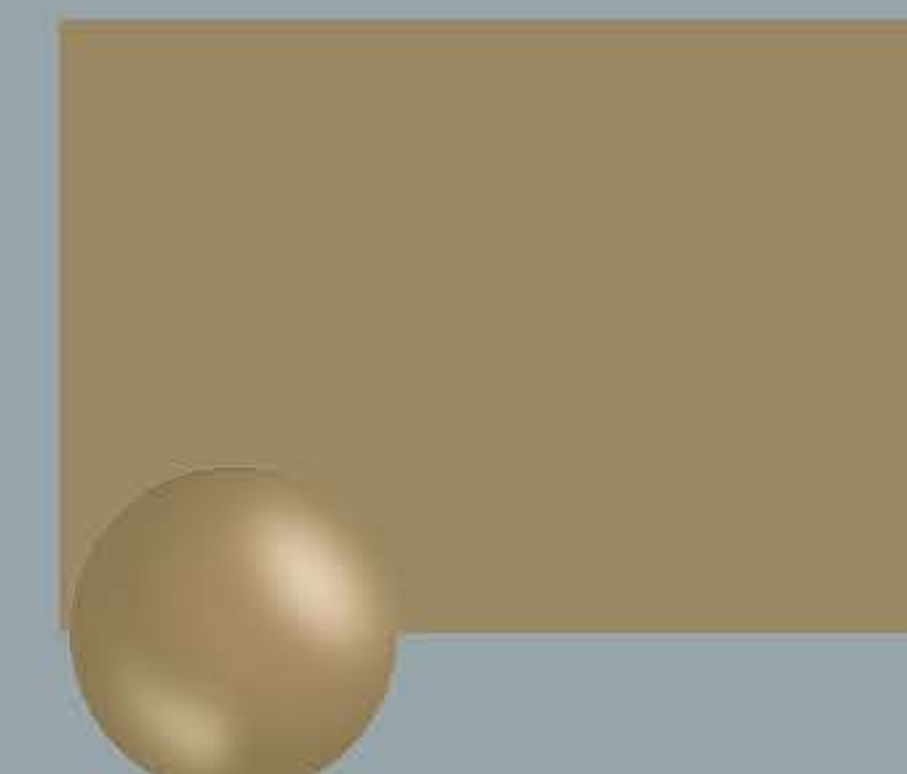

visone/mink

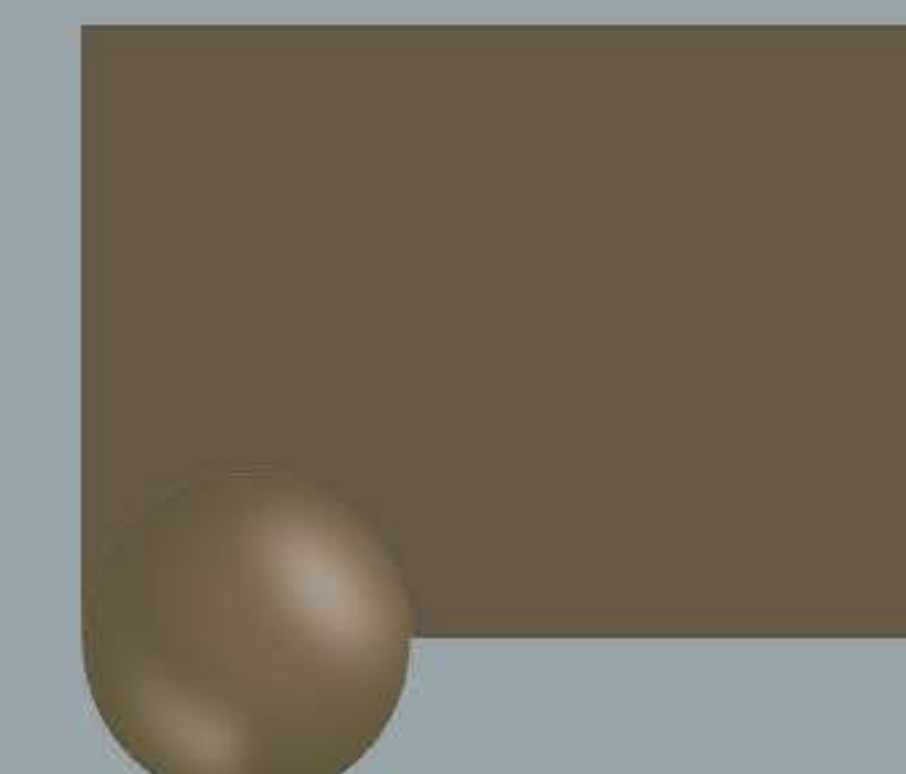

fango/mud

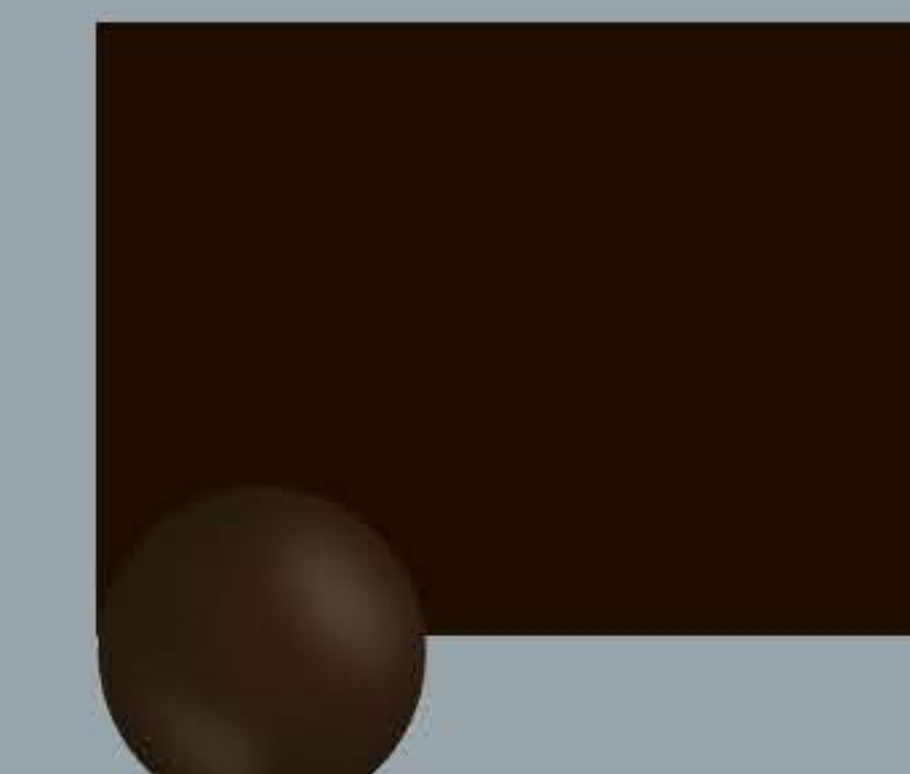

cioccolato/chocolate

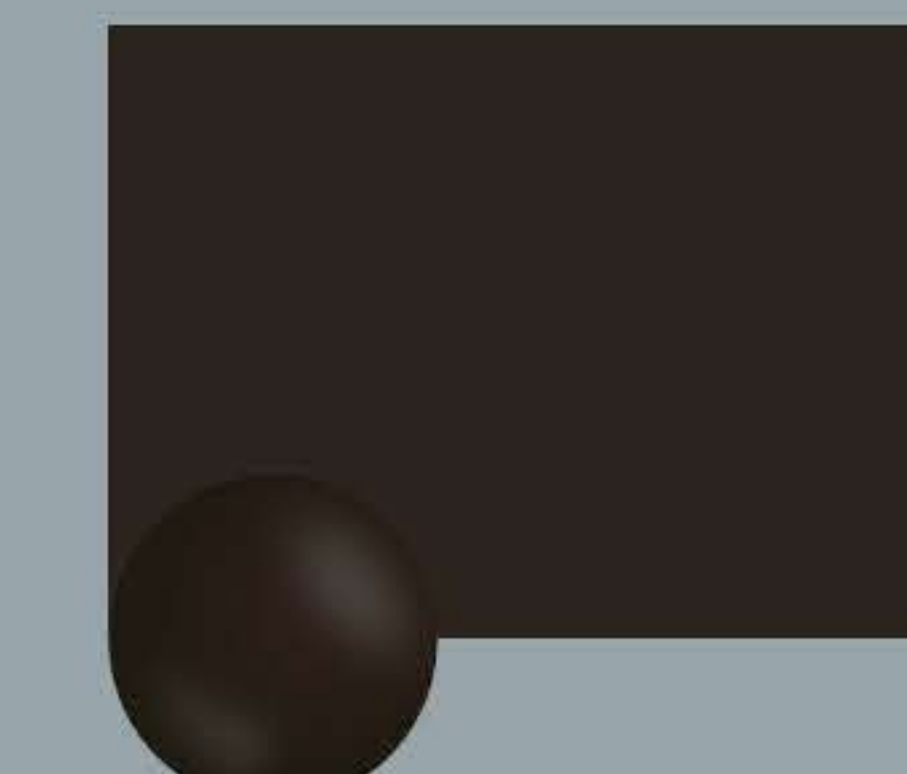

moro/dark brown

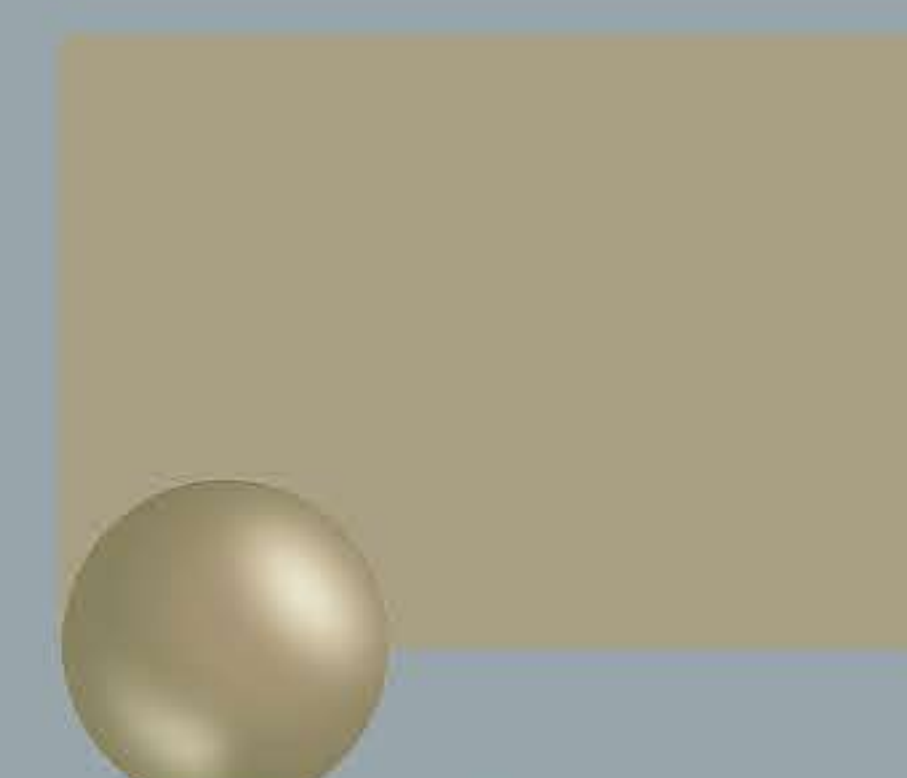

ghiaia/gravel

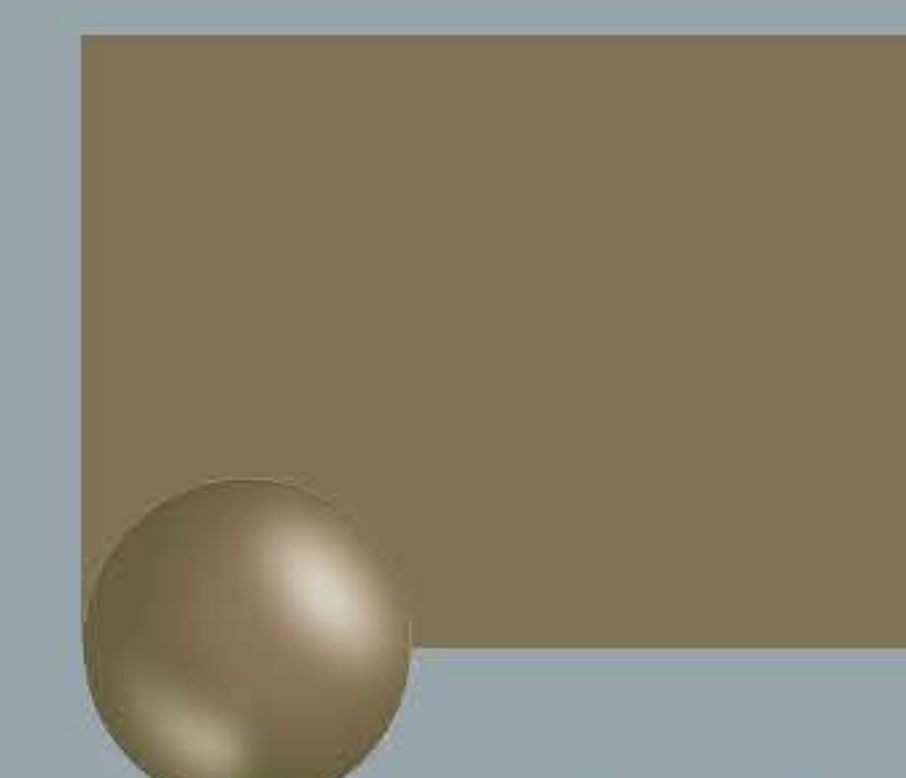

mastice/putty



terra/soil

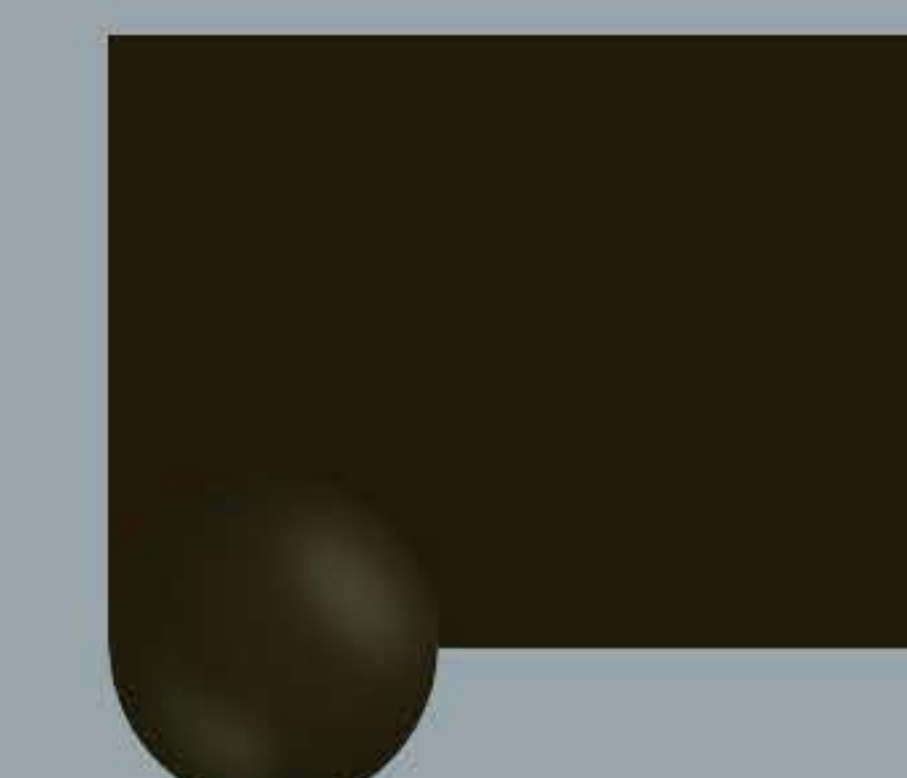

fucile/gunmetal

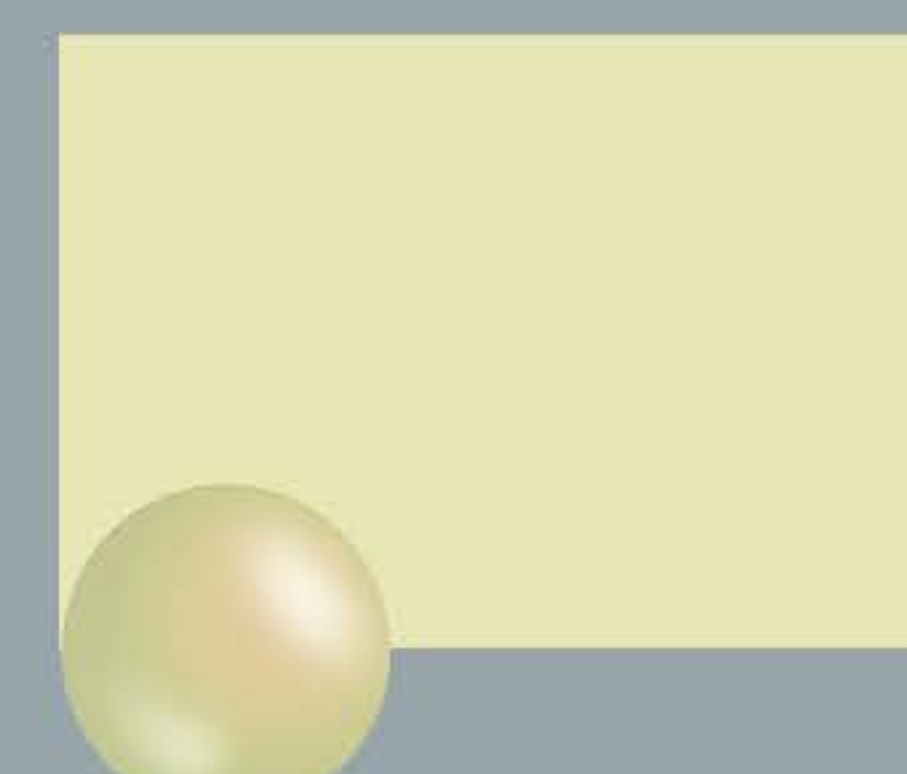

perla/pearl

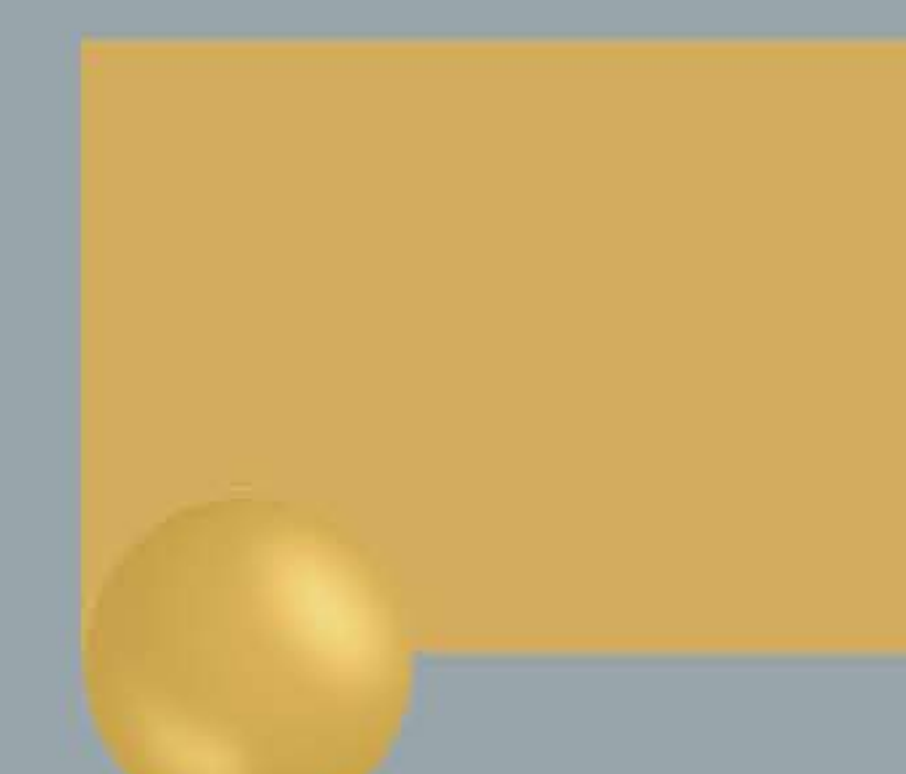

zenzero/ginger

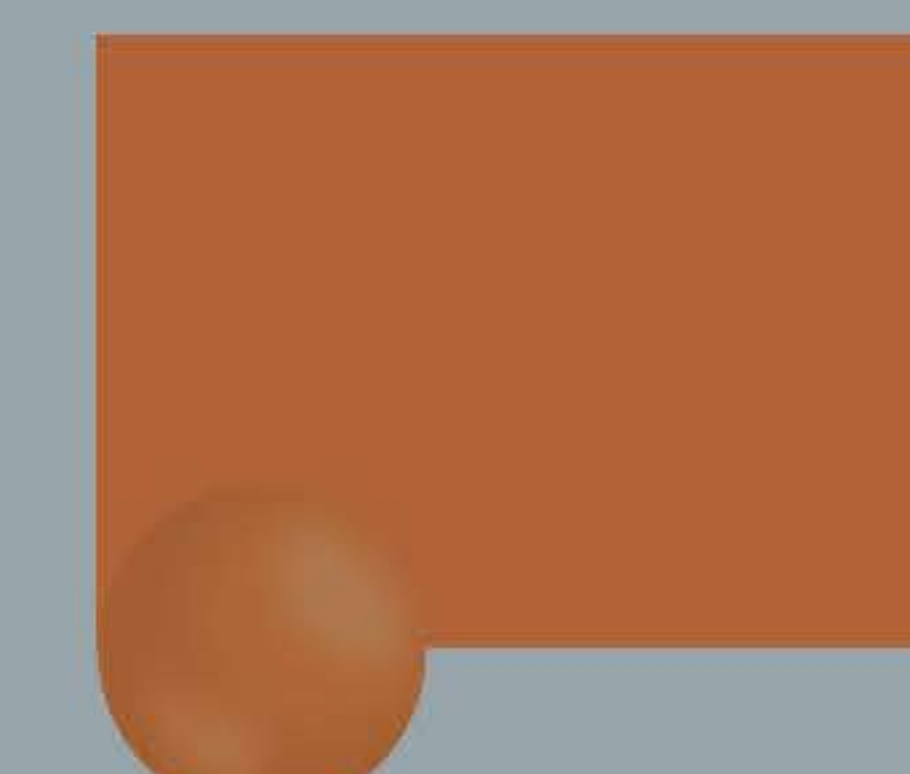

argilla/clay

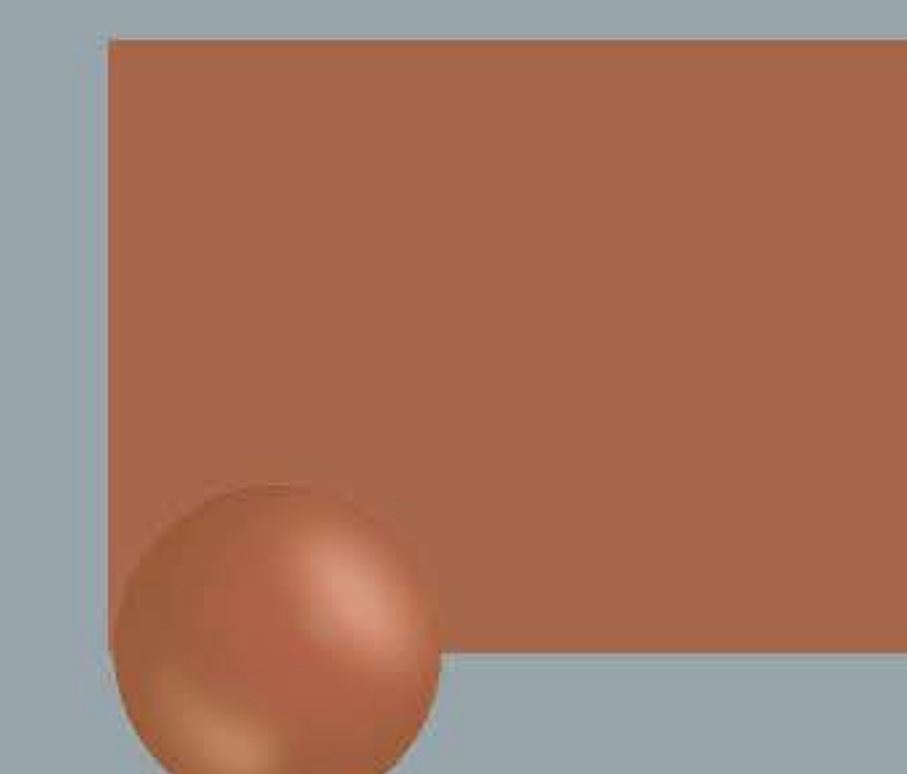

siena/sienna brown

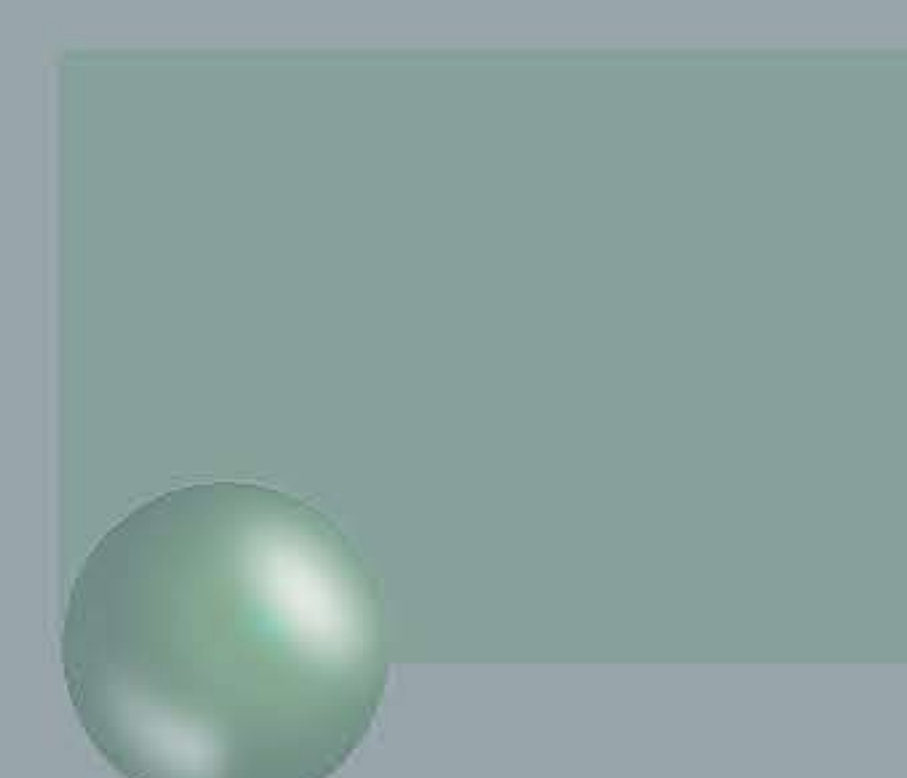

turchese/turquoise

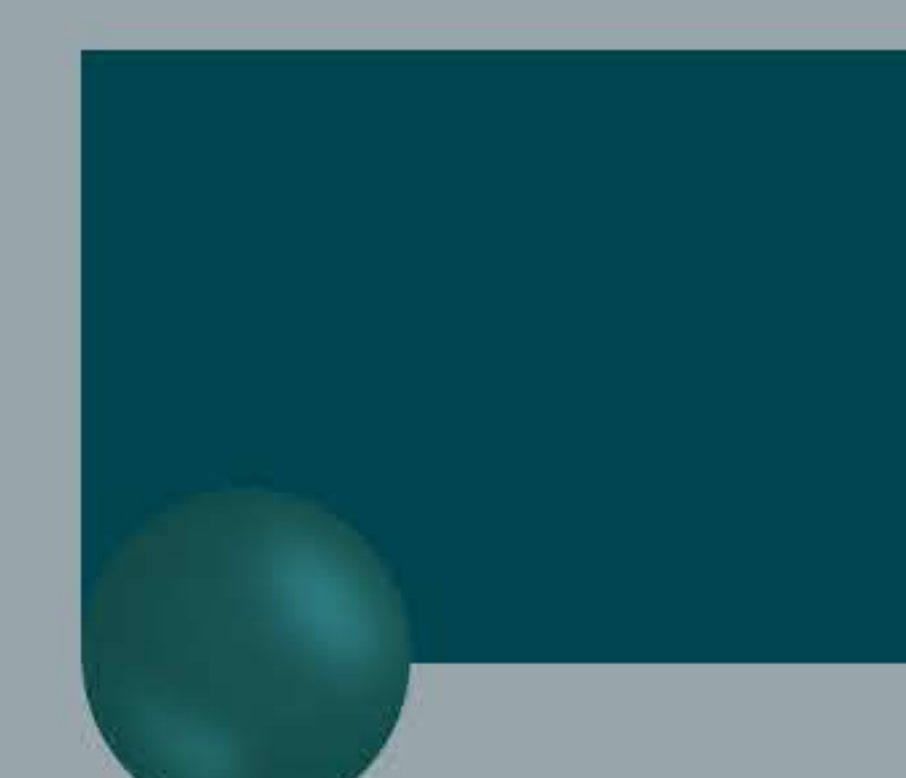

ottanio/teal



petrolio/petrol

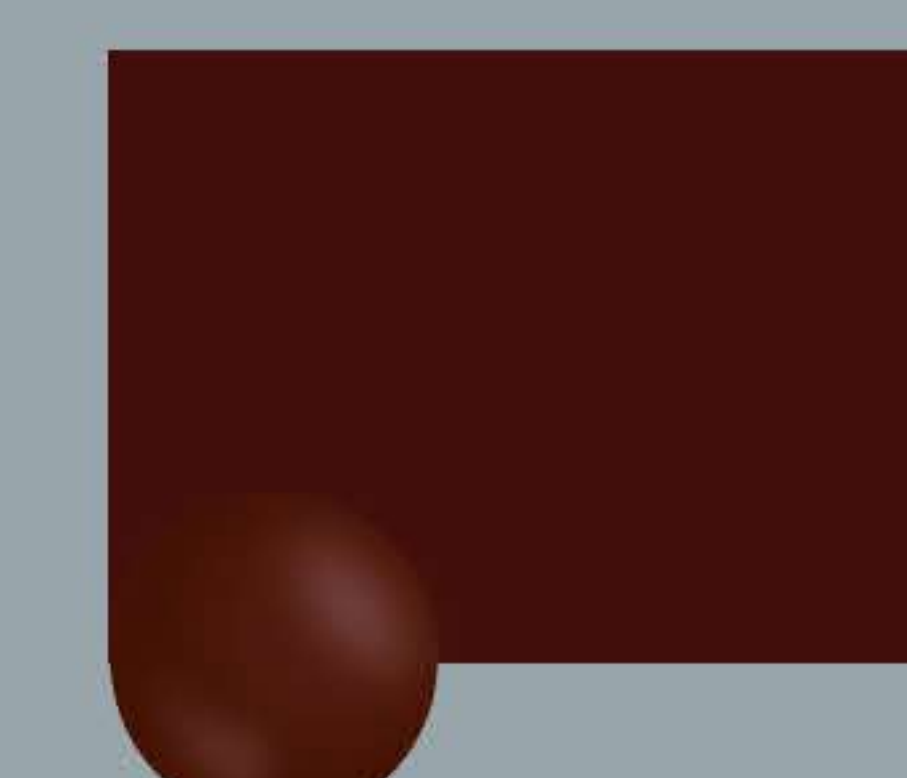

rubino/ruby

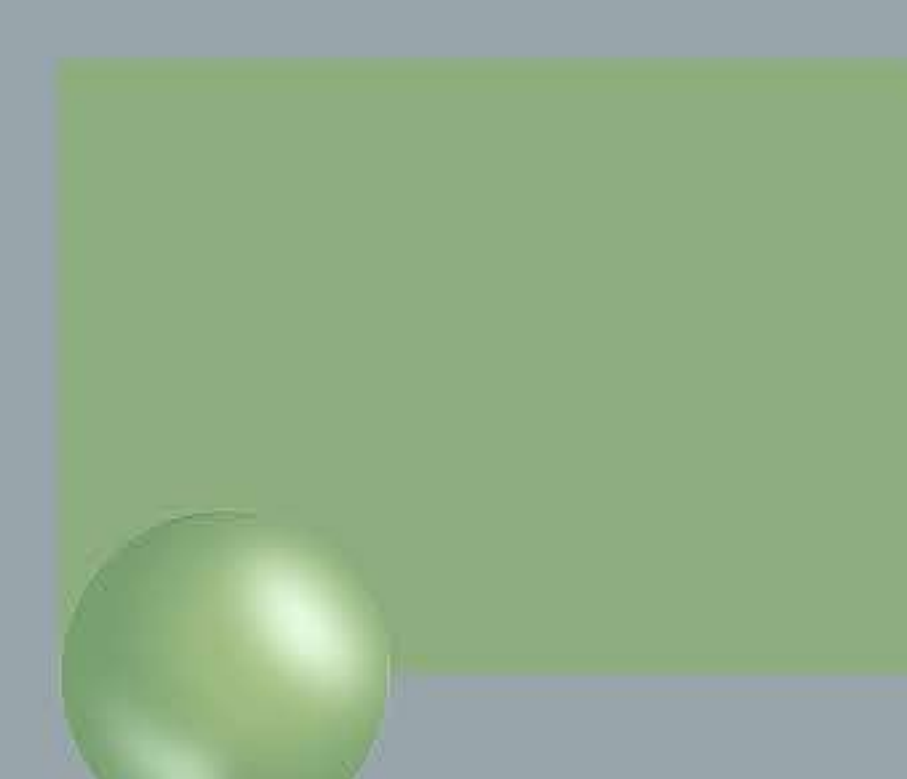

acqua/aqua green

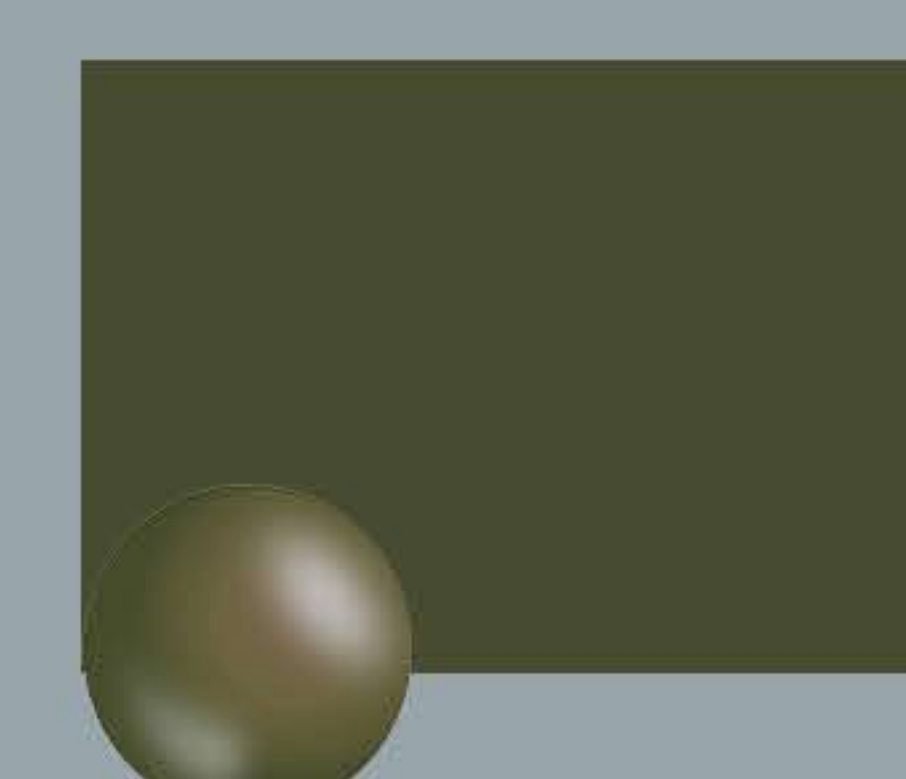

oliva/olive green

ROVERE LACCATO A PORO APERTO

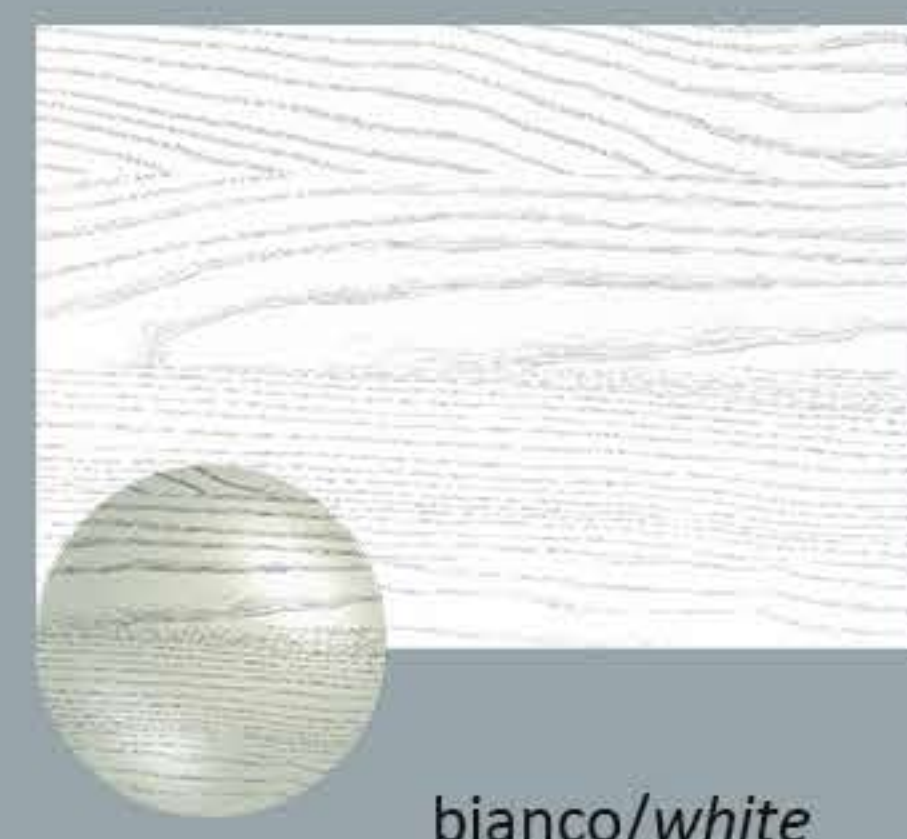

bianco/white



grafite/graphite



nero/black

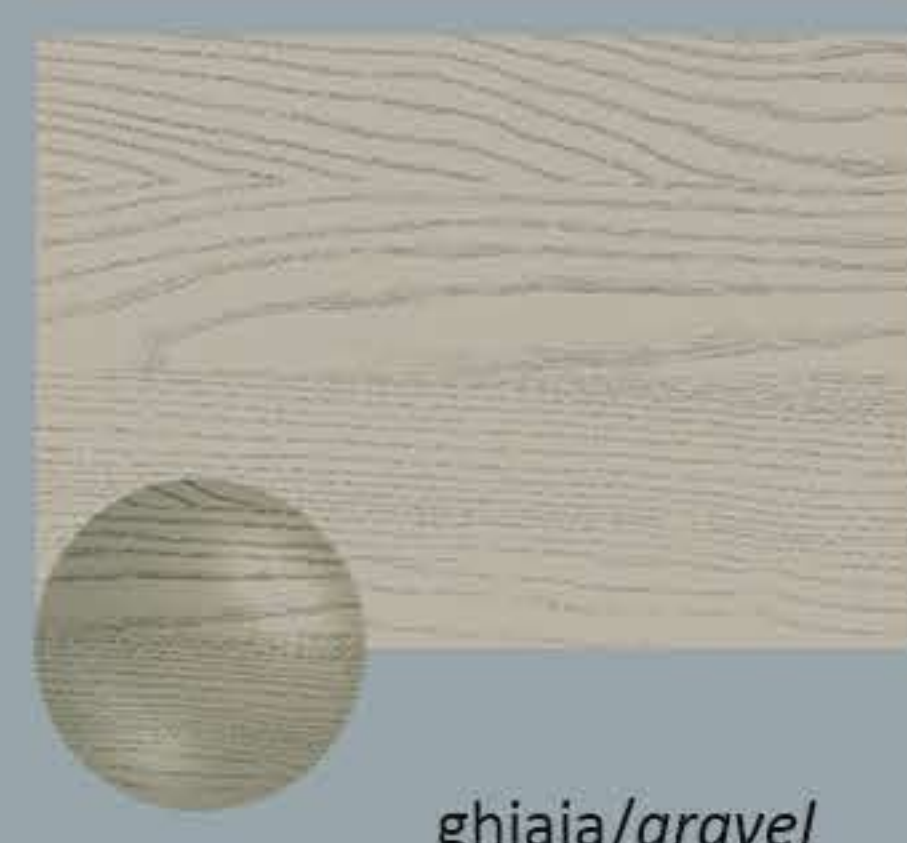

ghiaia/gravel



mastice/putty



terra/soil



moro/dark brown



perla/pearl

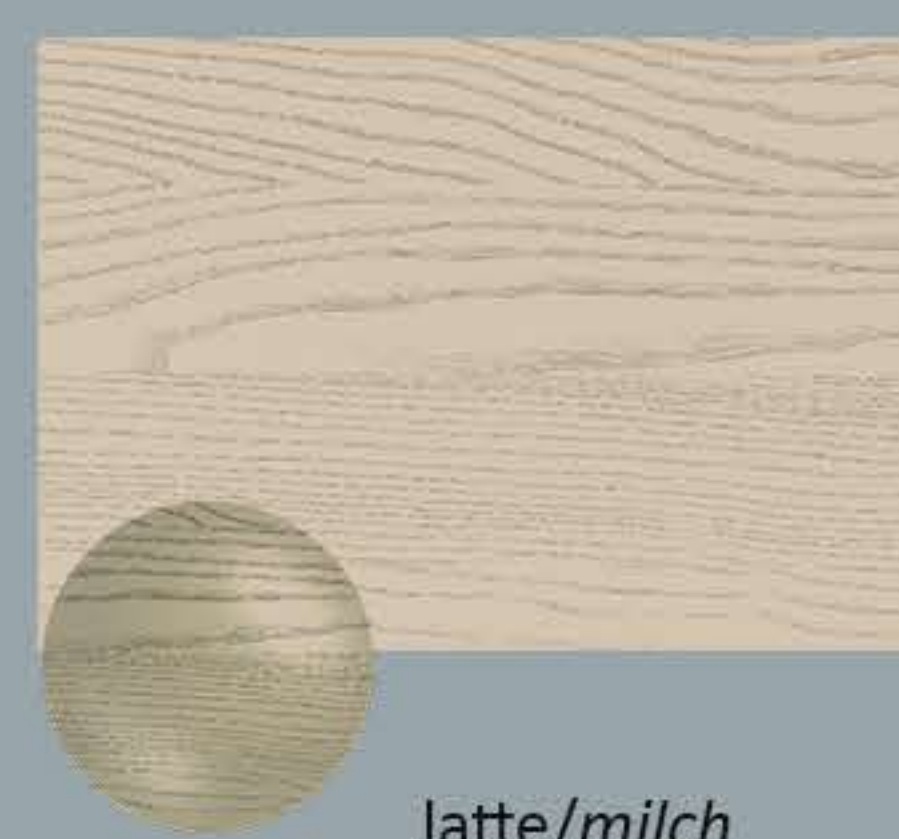

latte/milch



caffè/coffee

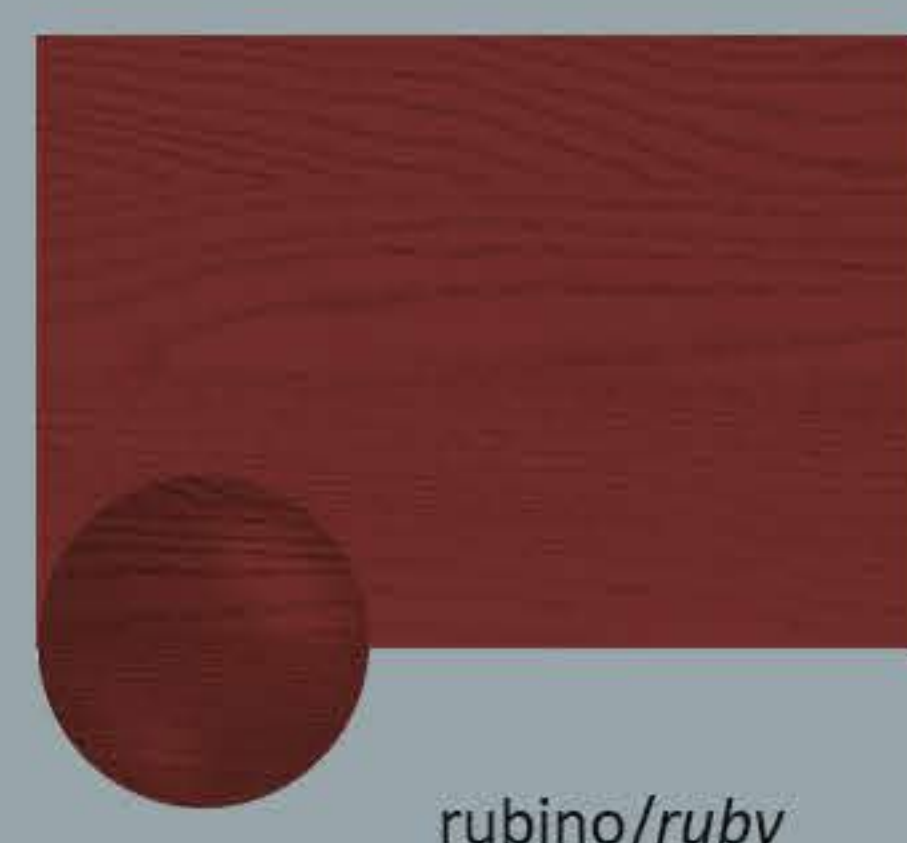

rubino/ruby

LACCATI METALLIZZATI



alluminio



palladio

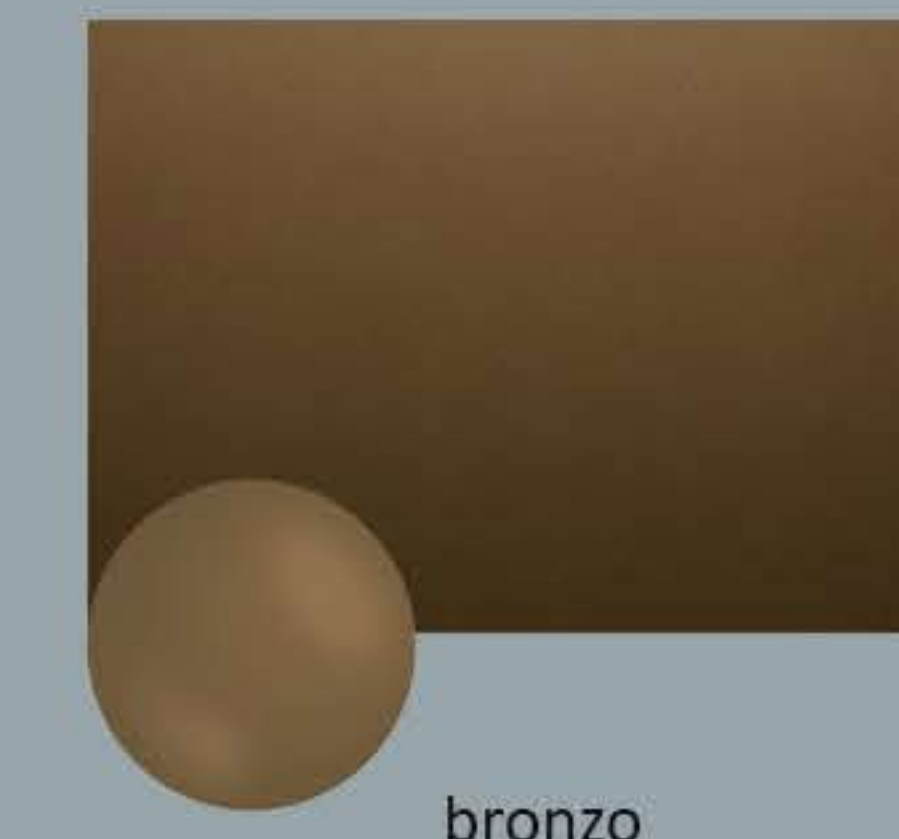

bronzo

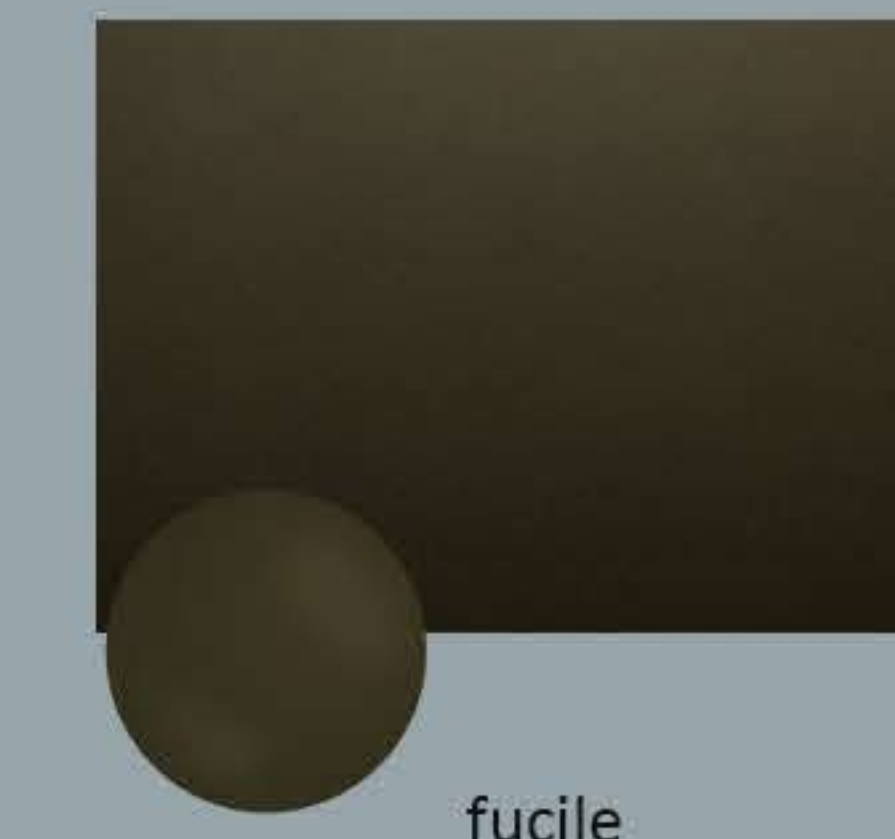

fucile

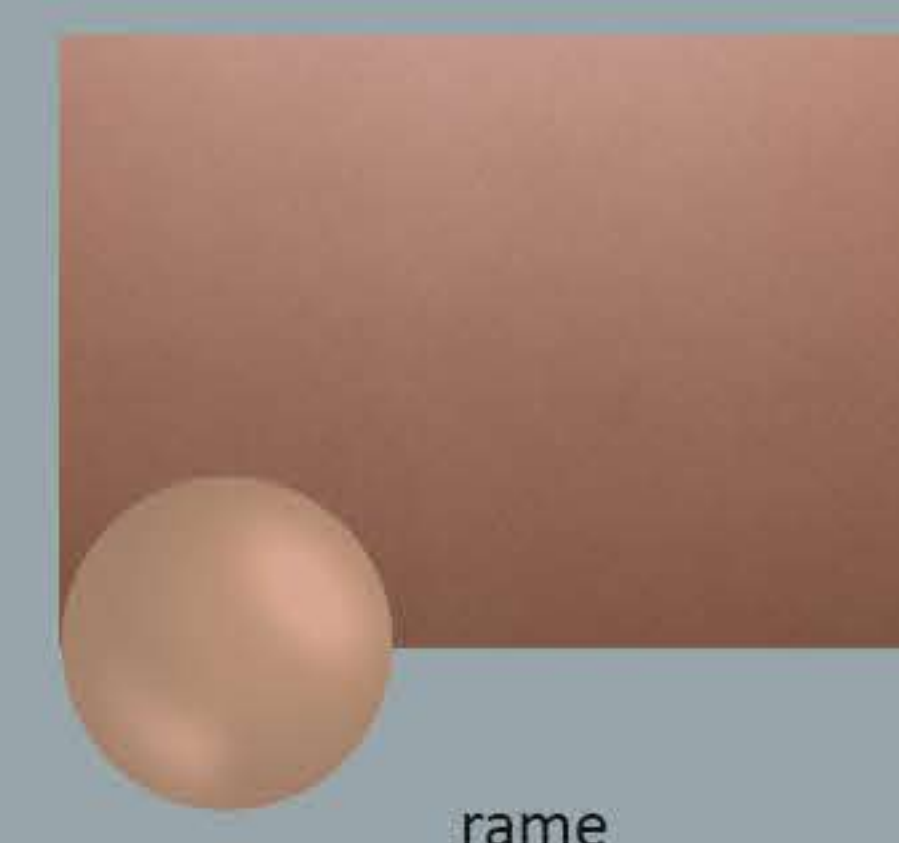

rame

GRES PORCELLANATO



statuario



golden white



tafu



frappuccino



emperador

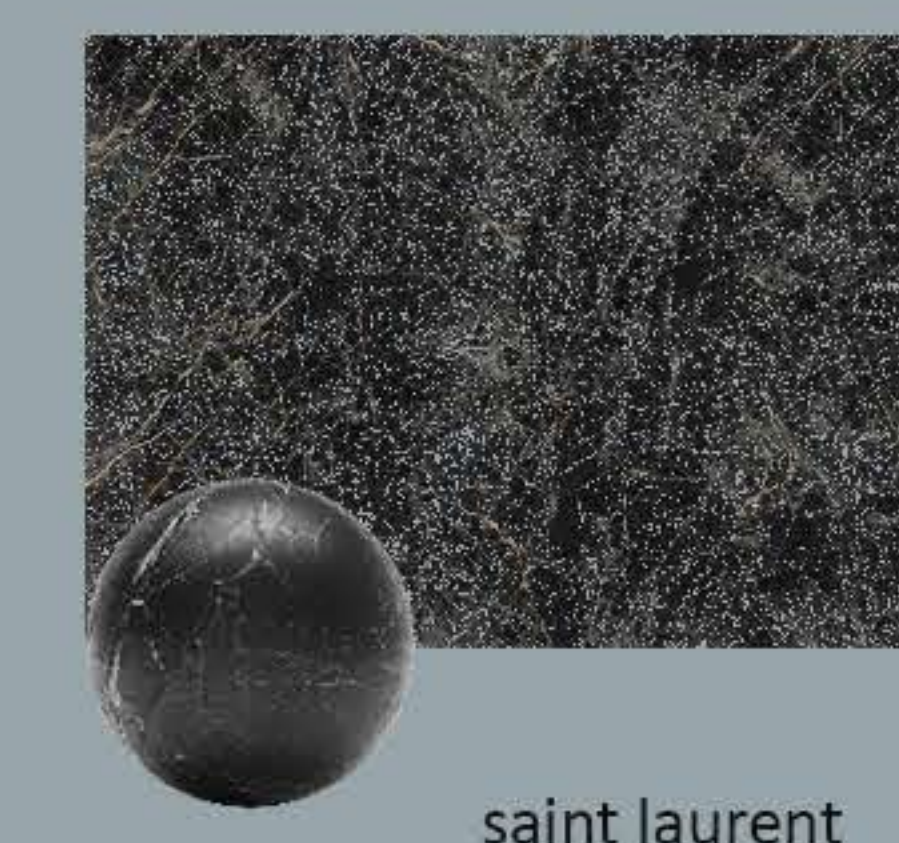

saint laurent

LETTI 4

LINEGiANSER

VIA SANT'AMBROGIO, 1

22066 MARIANO COMENSE

COMO - ITALY

TEL.: +39 031 745 554

FAX : +39 031 743 112

MAIL: INFO@LINEGIANSER.COM

WWW.LINEGIANSER.COM