

WARDROBE BOOK

LINEGIANSER

TUTTE LE NOTTI BOOK

WALK-IN-CLOSET

structural walk-in-closet

WARDROBE

leaf doors / sliding doors / coplanar doors

PANELLING

wall walk-in-closet / panelling

WALK-IN-CLOSET

structural walk-in-closet



COMPONENTI STRUTTURALI / STRUCTURE COMPONENTS

armadi e cabine armadio / wardrobe and walk-in-closet

Componenti / Components

- 1 - spalla laterale
end side
- 2 - spalla centrale
middle side
- 3 - coperchio
top shelf
- 4 - basamento
bottom shelf
- 5 - schienale
back panel

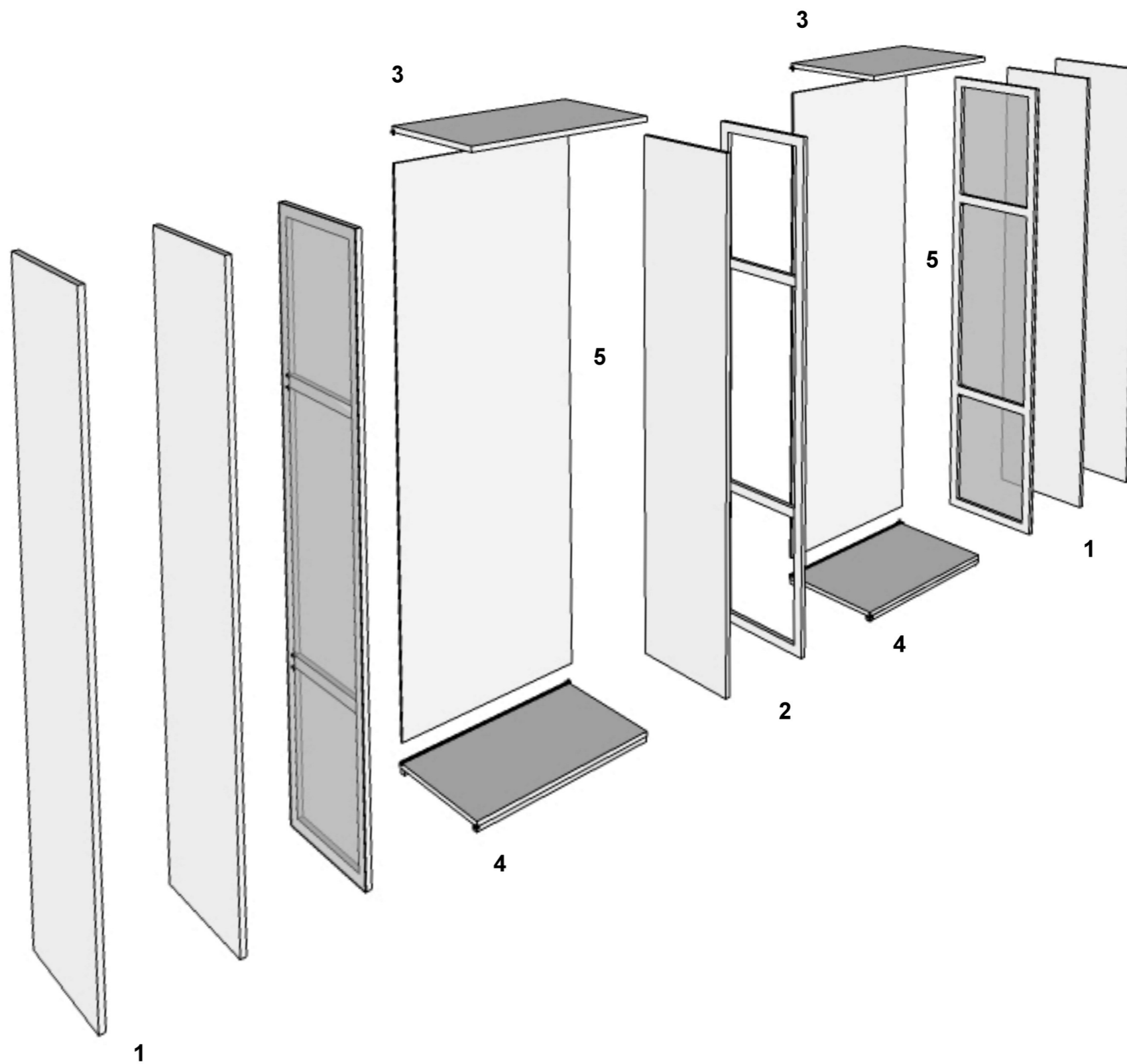

COMPONENTI STRUTTURALI / STRUCTURE COMPONENTS

armadi e cabine armadio / wardrobe and walk-in-closet

Tipologie fianchi / Sides types

1 - spalla esterna armadio spessore mm 25
lato esterno rovere tinto / rovere laccato / laccato
h. mm 2265 - 2585 - 2905 profondità mm 570

wardrobe external side thickness mm 25
outside painted oak / lacquered oak / lacquered
h. mm 2265 - 2585 - 2905 depht mm 570

2 - spalla esterna armadio spessore mm 27
lato esterno rivestito pelle / ecopelle
h. mm 2265 - 2585 - 2905 profondità mm 570

wardrobe external side thickness mm 27
outside leather / ecoleather covered
h. mm 2265 - 2585 - 2905 depht mm 570

3 - spalla esterna vetro armadio spessore mm 29
lato esterno vetro applicato
h. mm 2585 profondità mm 570

wardrobe external side thickness mm 29
outside glass covered
h. mm 2585 depht mm 570

4 - spalla interna armadio / cabina spessore mm 25
rovere tinto tabacco / laccato ghiaia
h. mm 2265 - 2585 - 2905 profondità mm 570

wardrobe / walk-in-closet side thickness mm 25
painted oak rovere tabacco / ghiaia lacquered
h. mm 2265 - 2585 - 2905 depht mm 570

5 - spalla armadio interna telaio spessore mm 25
alluminio laccato canna di fucile
h. mm 2585 profondità mm 570

wardrobe middle frame side thickness mm 25
aluminium canna di fucile lacquered
h. mm 2585 depht mm 570

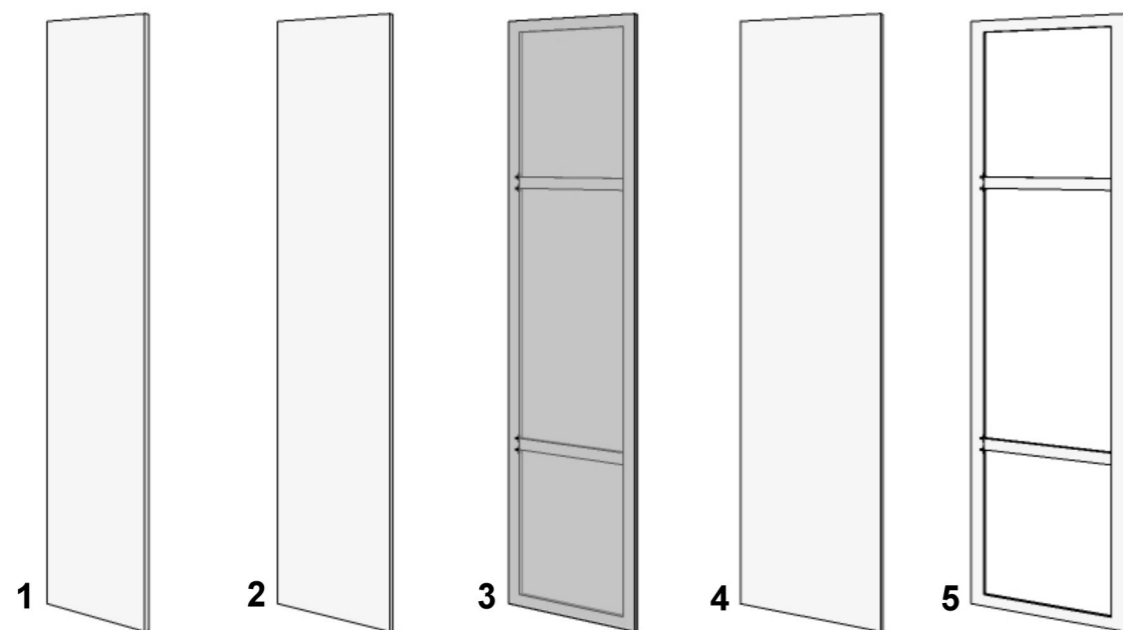

COMPONENTI STRUTTURALI / STRUCTURE COMPONENTS

armadi e cabine armadio / wardrobe and walk-in-closet

Tipologia schienali / Back panel types

1 - schienale armadio / cabina spessore mm 9
lato interno rovere tinto tabacco / laccato ghiaia
h. mm 2265 - 2585 - 2905
l. mm 465 - 585 - 945

wardrobe / walk-in-closet backpanel thickness mm 9
innerside painted rovere tabacco oak / ghiaia lacquered
h. mm 2265 - 2585 - 2905
l. mm 465 - 585 - 945

2 - schienale armadio / cabina spessore mm 10
lato interno rivestito pelle / ecopelle
h. mm 2265 - 2585 - 2905
l. mm 465 - 585 - 945

wardrobe / walk-in-closet backpanel thickness mm 10
innerside leather / ecoleather covered
h. mm 2265 - 2585 - 2905
l. mm 465 - 585 - 945

3 - schienale armadio / cabina spessore mm 20
lato interno rovere tinto tabacco / laccato ghiaia
h. mm 2265 - 2585 - 2905
l. mm 1185 - 1425

wardrobe / walk-in-closet backpanel thickness mm 20
innerside painted rovere tabacco oak / ghiaia lacquered
h. mm 2265 - 2585 - 2905
l. mm 1185 - 1425

4 - schienale armadio / cabina spessore mm 21
lato interno rivestito pelle / ecopelle
h. mm 2265 - 2585 - 2905
l. mm 1185 - 1425

wardrobe / walk-in-closet backpanel thickness mm 21
innerside leather / ecoleather covered
h. mm 2265 - 2585 - 2905
l. mm 1185 - 1425

5 - schienale vetro armadio (solo con spalle alluminio)
h. mm 2585
l. mm 465 - 945

wardrobe glass backpanel (only with aluminium side)
h. mm 2585
l. mm 465 - 945

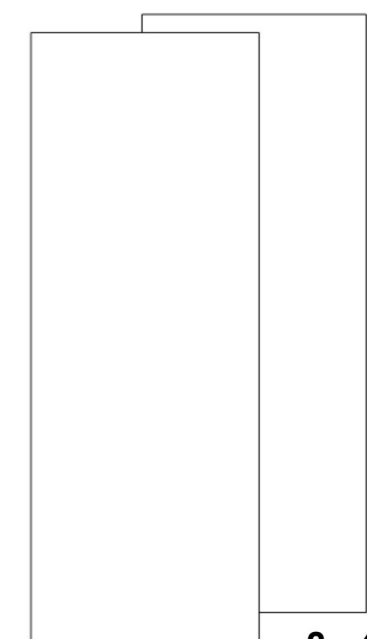

1 - 3

2 - 4

COMPONENTI STRUTTURALI / STRUCTURE COMPONENTS

armadi e cabine armadio / wardrobe and walk-in-closet

Tipologia ripiani / Shelves types

- 1** - ripiano armadio / cabina spessore mm 25
rovere tinto tabacco / laccato ghiaia
l. mm 455 - 575 - 695 - 935 - 1175 - 1415

wardrobe / walk-in-closet shelf thickness mm 25
oak painted rovere tabacco / ghiaia lacquered
l. mm 455 - 575 - 695 - 935 - 1175 - 1415



- 2** - ripiano armadio / cabina spessore mm 40
laccato ghiaia
l. mm 455 - 575 - 695 - 935 - 1175 - 1415

wardrobe / walk-in-closet shelf thickness mm 40
ghiaia lacquered
l. mm 455 - 575 - 695 - 935 - 1175 - 1415



- 3** - ripiano armadio / cabina spessore mm 10
vetro extrachiaro
l. mm 455 - 575 - 935

wardrobe / walk-in-closet shelf thickness mm 10
glass extralight
l. mm 455 - 575 - 935



- 4** - ripiano armadio / cabina in vetro
con telaio alluminio verniciato canna di fucile
l. mm 935

wardrobe / walk-in-closet glass shelf
with aluminium frame canna di fucile painted
l. mm 935



TIPOLOGIE DI APERTURA / OPENING TYPOLOGIES

armadi e cabine armadio / wardrobe and walk-in-closet

Ante a battente / Leaf doors

tutte le ante a battente sono fornite di serie con cerniere ammortizzate

all leaf doors are supplied as standard with soft closing hinges

tipo / types

Wood
Basic
Astor
Skin
Beta
Futura
Color
Halfa
Level
Plumb

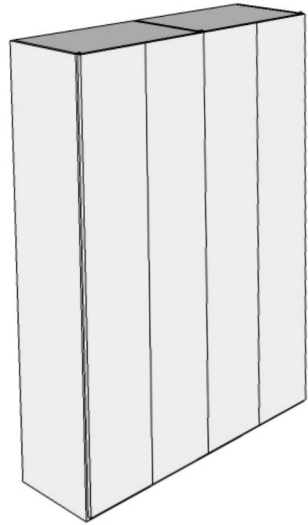

Ante scorrevoli / Sliding doors

tutte le ante scorrevoli sono fornite di serie con sistema di scorrimento ammortizzato

all sliding doors are supplied as standard with soft closing system

tipo / types

Basic
Skin
Beta
Futura
Color
Tris
Level
Plumb

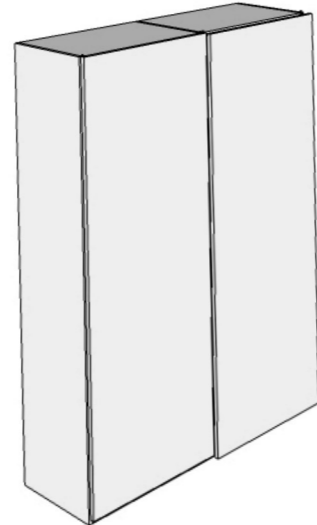

Ante complanari / Coplanar doors

tutte le ante complanari sono fornite di serie con sistema di scorrimento ammortizzato

all coplanar doors are supplied as standard with soft closing system

tipo / types

Skin
Tris
Level

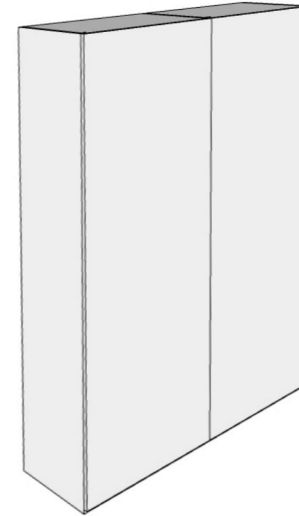

Cassetti / Drawers

tutti i cassetti esterni sono forniti con guide di scorrimento metalliche (abbinabili solo a ante a battente)

all drawers are supplied with metallic sliding system (to be used only with leaf doors)

tipo / types

Wood
Basic
Skin

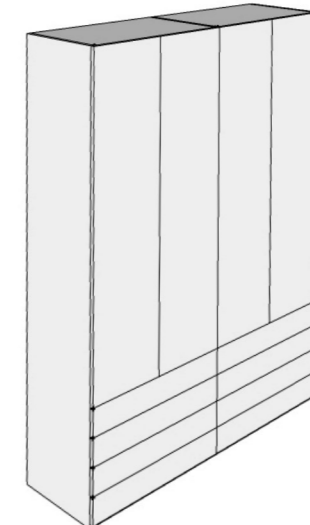

MODULARITA' STRUTTURA / STRUCTURE MODULARITY

cabine armadio / walk-in-closet

Modularità / Modularity

1 - spalla spessore 25 mm
side 25 mm thickness

2 - struttura 480 mm
(ripiano 455 mm + spalla 25 mm)
structure 480 mm
(shelf 455 mm + side 25 mm)

3 - struttura 600 mm
(ripiano 575 mm + spalla 25 mm)
structure 600 mm
(shelf 575 mm + side 25 mm)

4 - struttura 960 mm
(ripiano 935 mm + spalla 25 mm)
structure 960 mm
(shelf 935 mm + side 25 mm)

5 - struttura 1200 mm
(ripiano 1175 mm + spalla 25 mm)
structure 1200 mm
(shelf 1175 mm + side 25 mm)

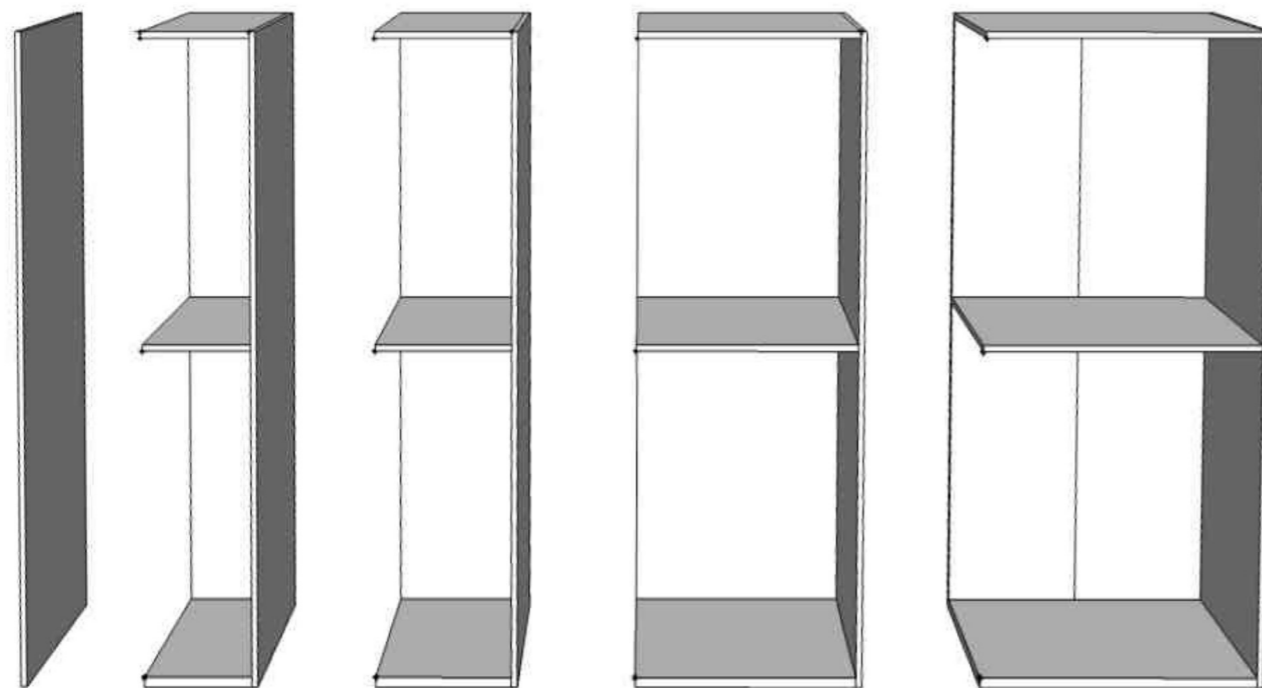

1

2

3

4

5

MODULARITA' STRUTTURA / STRUCTURE MODULARITY

armadi scorrevoli e complanari / sliding wardrobe and coplanar wardrobe

FINITURA STRUTTURA / STRUCTURE FINISHINGS

armadi e cabine armadio / wardrobe and walk-in-closet

Componenti strutturali / Structure components

1 - laccato ghiaia opaco
mat ghiaia lacquered

2 - rovere tinto tabacco
oak painted rovere tabacco



Attrezzatura interna/ Inside equipment

1 - laccato ghiaia opaco
mat ghiaia lacquered

2 - rovere tinto tabacco
oak painted rovere tabacco

3 - rovere tinto bruciato
oak painted rovere bruciato



FORATURA FIANCHI / SIDES DRILLING

armadi e cabine armadio / wardrobe and walk-in-closet

Forature di serie / Standard drillings

1 - fianco senza fori
side without holes

2 - foratura passo 320 mm
1 hole pitch 320 mm

3 - gruppo 3 fori passo 320 mm
3 holes pitch 320 mm

4 - foratura continua passo 64 mm
continuous drilling pitch 64 mm

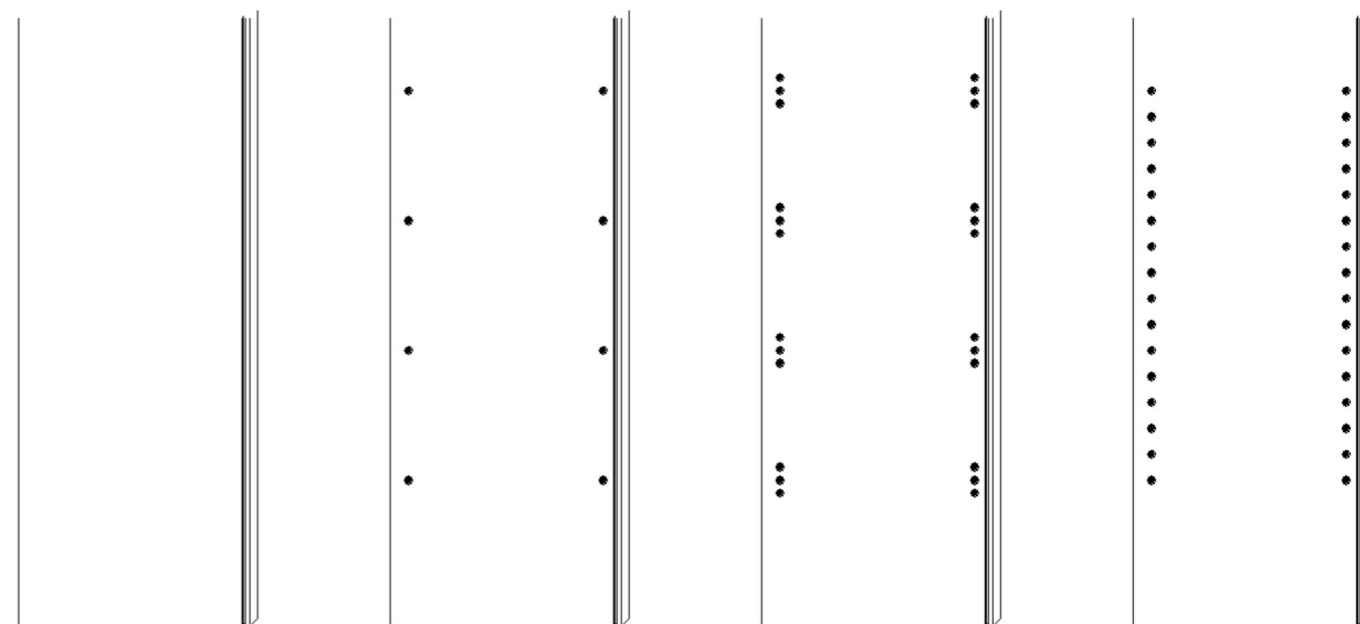

1

2

3

4

NB - è possibile richiedere forature personalizzate
se nulla è specificato sui fianchi verrà applicata la foratura 2
it is possible to have custom drilling
without specification drilling 2 will be made

ILLUMINAZIONE / LIGHTING

armadi e cabine armadio / wardrobe and walk-in-closet

Lampada led incassata ripiano legno Led lamp built-in in wooden shelf

lampada led a luce naturale 4000 K

- 1 accensione tramite collegamento a presa comandata
- 2 accensione con radiocomando a distanza
- 3 accensione tramite sensore ad apertura anta (escluse ante beta e halfa)

led lamp with natural light 4000 K

- 1 switch connected with controlled socket
- 2 switch with remote controller
- 3 automatic switch at door opening (not for door beta and halfa)

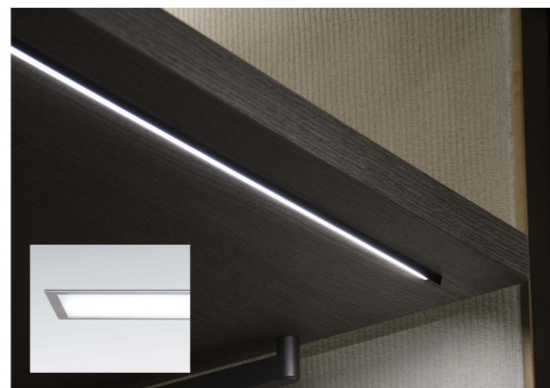

Striscia led incassata fianco legno Led stripe built-in wooden side

lampada led a luce naturale 4000 K

- 1 accensione tramite collegamento a presa comandata
- 2 accensione con radiocomando a distanza

led lamp with natural light 4000 K

- 1 switch connected with controlled socket
- 2 switch with remote controller

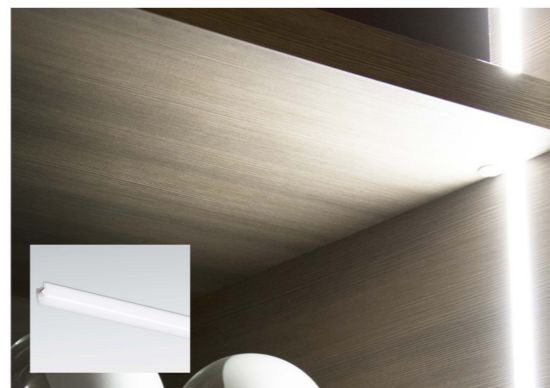

Faretti led da incasso Built-in led spot light

lampada led a luce naturale 4000 K

- 1 accensione tramite collegamento a presa comandata
- 2 accensione con radiocomando a distanza

led lamp with natural light 4000 K

- 1 switch connected with controlled socket
- 2 switch with remote controller



ILLUMINAZIONE / LIGHTING

armadi e cabine armadio / wardrobe and walk-in-closet

1 Accensione tramite collegamento a presa comandata Switch connected with controlled socket

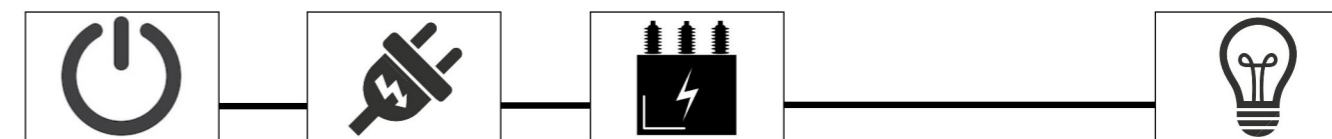

interruttore
switch

spina controllata
controlled socket

trasformatore
power trasformer

luce led
led light

2 Accensione con radiocomando a distanza Switch with remote controller

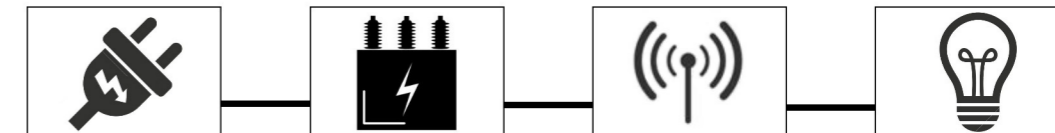

spina
socket

trasformatore
power trasformer

centralina
radiocomando
remote control
unit

luce led
led light

3 Accensione tramite sensore ad apertura anta Automatic switch at door opening

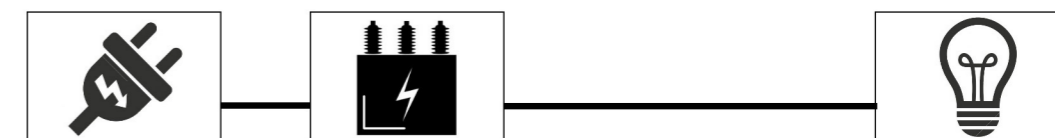

spina
socket

trasformatore
power trasformer

luce led
led light

ATTREZZATURE INTERNE / INSIDE EQUIPMENT

armadi e cabine armadio / wardrobe and walk-in-closet

1 - cassetiera a terra cassetti legno
freestanding chest of drawers with
wooden drawers

2 - cassetiera a terra cassetti vetro
freestanding chest of drawers with
glass drawers

3 - cassetiera sospesa cassetti legno
hanging chest of drawers with
wooden drawers

4 - cassetiera sospesa cassetti vetro
hanging chest of drawers with
glass drawers

5 - ripiano legno
wooden shelf

6 - ripiano vetro con cornice
glass shelf with aluminium
frame

7 - tubo appendiabiti
hanging rail

8 - servetto
pull down hanging bar

9 - vassoio metallico
estraibile
pull out metalic tray

10 - vassoio metallico con
divisorio estraibile
pull out metalic tray with
inside divider

11 - porta scarpe inclinato
inclined shoes shelf

12 - sacche porta bianchria
estraibile
pull out laundry bags

13 - porta pantaloni estraibile
pull out trousers hanger

14 - porta camice
shirt storage

15 - porta borse
bag storage

16 - porta occhiali
glass storage

17 - porta orologi
watch winder

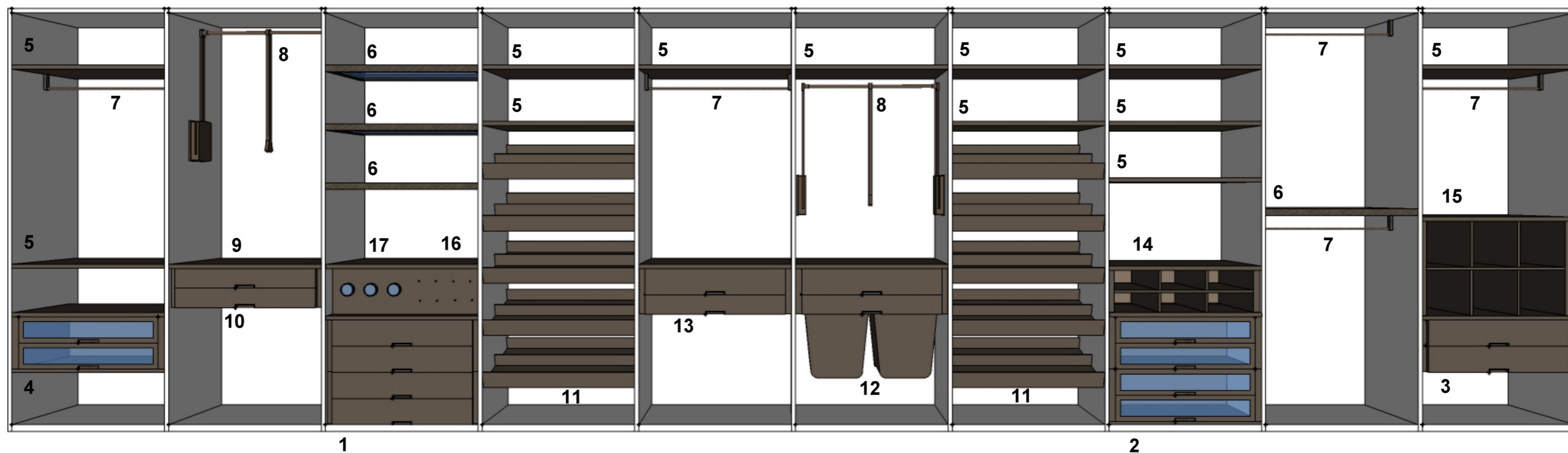

ATTREZZATURE INTERNE / INSIDE EQUIPMENT

armadi e cabine armadio / wardrobe and walk-in-closet

Esempi organizzazione colonne / Inner organization examples

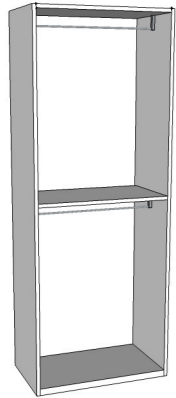

1 ripiano
2 tubi appendiabiti

1 shelf
2 hanging rails

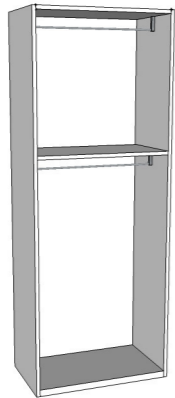

1 ripiano
2 tubi appendiabiti

1 shelf
2 hanging rails

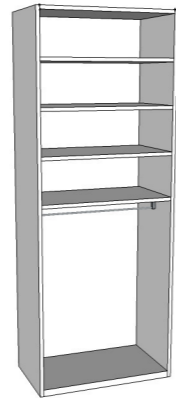

4 ripiani
1 tubo appendiabiti

4 shelves
1 hanging rail

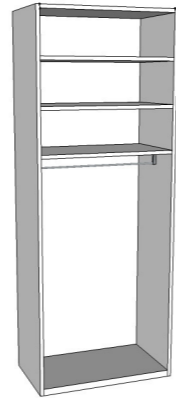

3 ripiani
1 tubo appendiabiti

3 shelves
1 hanging rail



4 ripiani
2 cassetti legno

4 shelves
2 wooden drawers

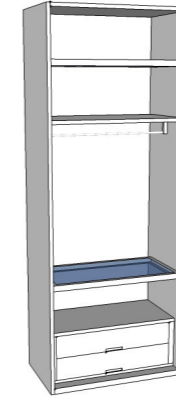

2 ripiani legno
1 ripiano vetro
2 cassetti legno
1 tubo appendiabiti

2 wooden shelves
1 glass shelf
2 wooden drawers
1 hanging rail

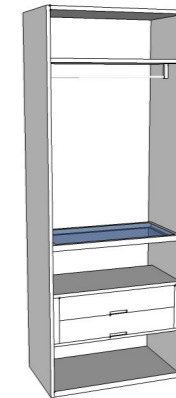

1 ripiano legno
1 ripiano vetro
2 cassetti legno
1 tubo appendiabiti

1 wooden shelf
1 glass shelf
2 wooden drawers
1 hanging rail

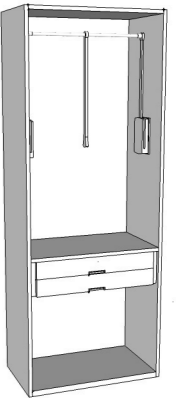

1 servetto
1 vassoio metallo
1 vassoio metallo
con divisorio

1 servetto
1 metallic tray
1 metallic tray
with divider

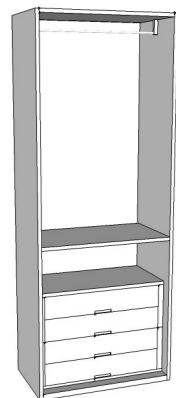

1 ripiano
4 cassetti legno
1 tubo appendiabiti

1 shelf
4 wooden drawers
1 hanging rail

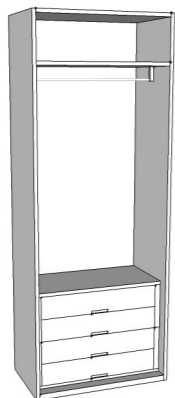

1 ripiano
4 cassetti legno
1 tubo appendiabiti

1 shelf
4 wooden drawers
1 hanging rail

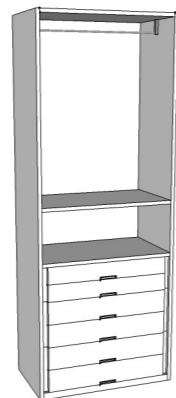

1 ripiano
6 cassetti legno
1 tubo appendiabiti

1 shelf
6 wooden drawers
1 hanging rail

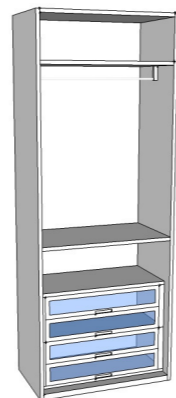

1 ripiano
4 cassetti vetro
1 tubo appendiabiti

1 shelf
4 glass drawers
1 hanging rail

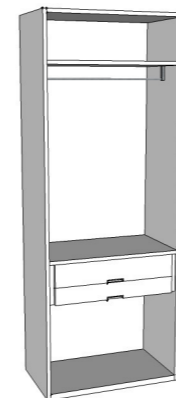

1 ripiano legno
1 cassetto legno
1 vassoio metallo
1 tubo appendiabiti

1 wooden shelf
1 wooden drawer
1 metallic tray
1 hanging rail

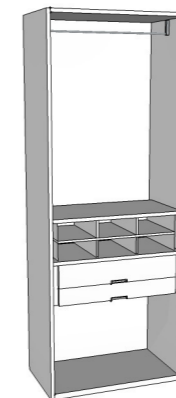

1 cassetto legno
1 vassoio metallo
1 porta camice
1 tubo appendiabiti

1 wooden drawer
1 metallic tray
1 shirt storage
1 hanging rail

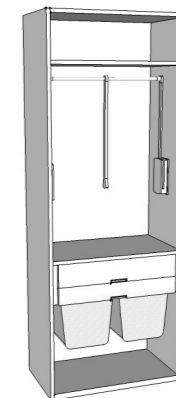

1 ripiano legno
1 cassetto legno
1 porta sacche
1 servetto

1 wooden shelf
1 wooden drawer
1 laundry bags
1 servetto

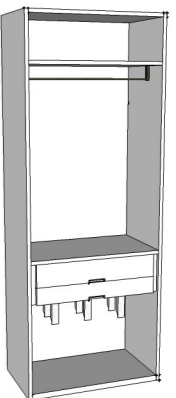

1 ripiano legno
1 cassetto legno
1 vassoio metallo
1 porta stivali
1 tubo appendiabiti

1 wooden shelf
1 wooden drawer
1 metallic tray
1 boots tray
1 hanging rail

ATTREZZATURE INTERNE / INSIDE EQUIPMENT

armadi e cabine armadio / wardrobe and walk-in-closet

Esempi organizzazione colonne / Inner organization examples

ATTREZZATURE INTERNE / INSIDE EQUIPMENT

armadi e cabine armadio / wardrobe and walk-in-closet

Esempi organizzazione colonne / Inner organization examples

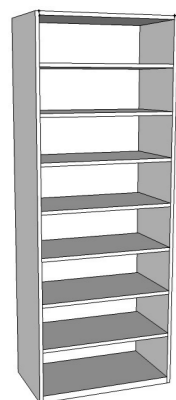

7 ripiani legno
7 wooden shelves

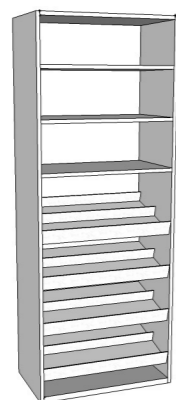

3 ripiani legno
4 porta scarpe
3 wooden shelves
4 shoes shelves

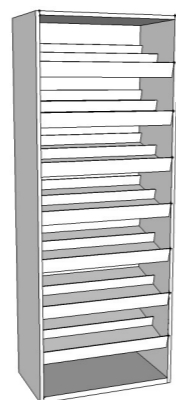

7 porta scarpe
7 shoes shelves

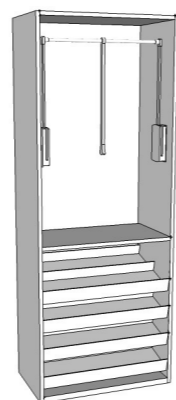

1 ripiano legno
4 porta scarpe
1 servetto
1 wooden shelf
4 shoes shelves
1 servetto

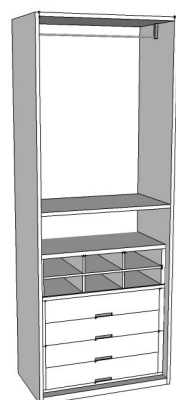

1 ripiano legno
4 cassetti legno
1 porta camice
1 tubo appendiabiti
1 wooden shelf
4 wooden drawers
1 shirt storage
1 hanging rail



2 ripiani vetro
6 cassetti legno
1 porta camice
2 glass shelves
6 wooden drawers
1 shirt storage

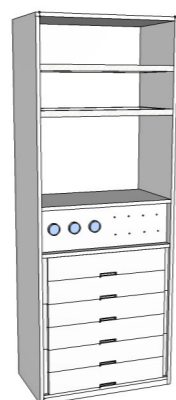

2 ripiani vetro
6 cassetti legno
1 porta occhiali
3 porte orologi
2 glass shelves
6 wooden drawers
1 glass storage
3 watch winder

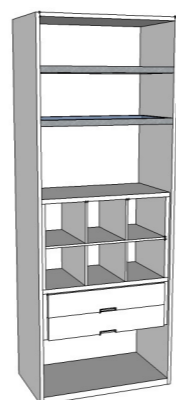

2 ripiani vetro
2 cassetti legno
1 porta borse
2 glass shelves
2 wooden drawers
1 bag storage

ATTREZZATURE INTERNE / INSIDE EQUIPMENT

serie standard armadi e cabine armadio / standard set for wardrobe and walk-in-closet

Cassettiere / Chest of drawers



1 - coperchio di finitura superiore cassetiera
spessore mm 25 rovere tinto tabacco / laccato ghiaia
l. mm 455 - 575 - 695 - 935 - 1175 - 1415

chest of drawers finishing top shelf
thickness mm 25 oak painted tabacco / ghiaia lacquered
l. mm 455 - 575 - 695 - 935 - 1175 - 1415

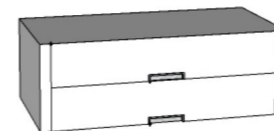

2 - elemento a 2 cassetti legno
altezza mm 320 rovere tinto tabacco / laccato ghiaia
l. mm 455 - 575 - 695 - 935

2 wooden drawers unit
height mm 320 oak painted tabacco / ghiaia lacquered
l. mm 455 - 575 - 695 - 935



3 - elemento a 1 cassettone legno
altezza mm 320 rovere tinto tabacco / laccato ghiaia
l. mm 455 - 575 - 695 - 935

1 wooden big drawer unit
height mm 320 oak painted tabacco / ghiaia lacquered
l. mm 455 - 575 - 695 - 935

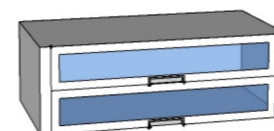

4 - elemento a 2 cassetti vetro
altezza mm 320 rovere tinto tabacco / laccato ghiaia
l. mm 935

2 glass drawers unit
height mm 320 oak painted tabacco / ghiaia lacquered
l. mm 935



5 - basamento per cassetiera
spessore mm 20 rovere tinto tabacco / laccato ghiaia
l. mm 455 - 575 - 695 - 935

2 chest of drawers bottom
thickness mm 20 oak painted tabacco / ghiaia lacquered
l. mm 455 - 575 - 695 - 935

ATTREZZATURE INTERNE / INSIDE EQUIPMENT

serie standard armadi e cabine armadio / standard set for wardrobe and walk-in-closet

Cassettiere / Chest of drawers

cassettiere a terra e cassettiere sospese
con cassetti legno larghezza 455 mm
altezza 365 mm per modulo base a 2 cassetti
+ 320 mm per ogni modulo aggiuntivo

freestanding and hanging chest of drawers
with wooden drawers width 455 mm
height 365 mm for basic 2 drawers element
+ 320 mm for each added element



cassettiere a terra e cassettiere sospese
con cassetti legno larghezza 575 mm
altezza 365 mm per modulo base a 2 cassetti
+ 320 mm per ogni modulo aggiuntivo

freestanding and hanging chest of drawers
with wooden drawers width 575 mm
height 365 mm for basic 2 drawers element
+ 320 mm for each added element



cassettiere a terra e cassettiere sospese
con cassetti legno larghezza 695 mm
altezza 365 mm per modulo base a 2 cassetti
+ 320 mm per ogni modulo aggiuntivo

freestanding and hanging chest of drawers
with wooden drawers width 695 mm
height 365 mm for basic 2 drawers element
+ 320 mm for each added element



cassettiere a terra e cassettiere sospese
con cassetti legno o vetro larghezza 935 mm
altezza 365 mm per modulo base a 2 cassetti
+ 320 mm per ogni modulo aggiuntivo

freestanding and hanging chest of drawers
with wooden or glass drawers width 935 mm
height 365 mm for basic 2 drawers element
+ 320 mm for each added element



ATTREZZATURE INTERNE / INSIDE EQUIPMENT

serie standard armadi e cabine armadio / standard set for wardrobe and walk-in-closet

Cassettiere / Chest of drawers

cassettiere a terra larghezza 1175 mm
con 2 serie cassetti legno larghezza 575 mm
altezza 365 mm per modulo base a 2 cassetti
+ 320 mm per ogni modulo aggiuntivo

freestanding chest of drawers width 1175 mm
with 2 sets of wooden drawers width 575 mm
height 365 mm for basic 2 drawers element
+ 320 mm for each added element



cassettiere a terra larghezza 1175 mm
con 1 serie cassetti legno larghezza 695 mm
altezza 365 mm per modulo base a 2 cassetti
+ 320 mm per ogni modulo aggiuntivo

freestanding chest of drawers width 1175 mm
with 1 set of wooden drawers width 695 mm
height 365 mm for basic 2 drawers element
+ 320 mm for each added element

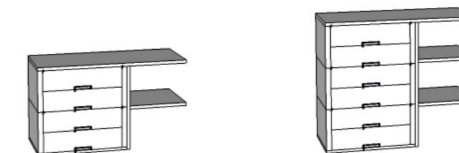

cassettiere a terra larghezza 1415 mm
con 2 serie cassetti legno larghezza 695 mm
altezza 365 mm per modulo base a 2 cassetti
+ 320 mm per ogni modulo aggiuntivo

freestanding chest of drawers width 1415 mm
with 2 sets of wooden drawers width 695 mm
height 365 mm for basic 2 drawers element
+ 320 mm for each added element



cassettiere a terra larghezza 1415 mm
con 1 serie cassetti legno larghezza 935 mm
altezza 365 mm per modulo base a 2 cassetti
+ 320 mm per ogni modulo aggiuntivo

freestanding chest of drawers width 1415 mm
with 1 set of wooden drawers width 935 mm
height 365 mm for basic 2 drawers element
+ 320 mm for each added element

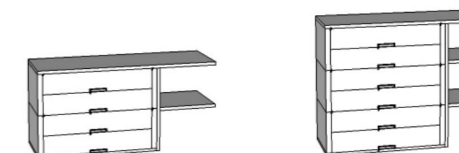

ATTREZZATURE INTERNE / INSIDE EQUIPMENT

serie standard armadi e cabine armadio / standard set for wardrobe and walk-in-closet

Elementi metallici / Metal elements

vassoio sospeso estraibile in metallo
verniciato color canna di fucile
larghezza 935 mm

hanging extractable tray in metal
lacquered canna di fucile color
width 935 mm

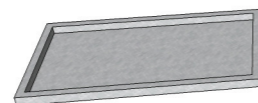

vassoio sospeso estraibile in metallo
completo di griglia divisoria
verniciato color canna di fucile
larghezza 935 mm

hanging extractable tray in metal
with partition element
lacquered canna di fucile color
width 935 mm

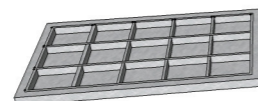

porta pantaloni sospeso estraibile
verniciato color canna di fucile
in metallo larghezza 935 mm

hanging extractable trousers hanger
lacquered canna di fucile color
in metal width 935 mm

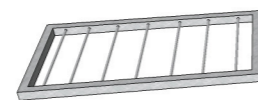

porta sacche sospeso estraibile
verniciato color canna di fucile
in metallo larghezza 935 mm

hanging extractable laundry bags
lacquered canna di fucile color
in metal width 935 mm

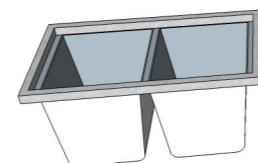

ATTREZZATURE INTERNE / INSIDE EQUIPMENT

serie standard armadi e cabine armadio / standard set for wardrobe and walk-in-closet

Attrezzature standard / Standard equipment

elemento portacamice larghezza 935 mm
con divisorio laccato canna di fucile
da utilizzarsi in appoggio su ripiani o cassettiere

shirts storage width 935 mm
with divider lacquered canna di fucile colour
to be used on top of shelf or chest of drawers

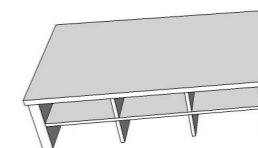

elemento portaborse larghezza 935 mm
con divisorio laccato canna di fucile
da utilizzarsi in appoggio su ripiani o cassettiere

bags storage width 935 mm
with divider lacquered canna di fucile colour
to be used on top of shelf or chest of drawers

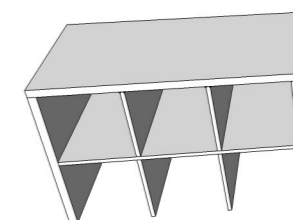

elemento porta occhiali larghezza 935 mm
con pannello laccato canna di fucile
da utilizzarsi in appoggio su ripiani o cassettiere
generalmente abbinato a porta orologi

glass storage width 935 mm
with panel lacquered canna di fucile colour
to be used on top of shelf or chest of drawers
usually in combination with watch winder

elemento porta orologi larghezza 935 mm
con pannello laccato canna di fucile
da utilizzarsi in appoggio su ripiani o cassettiere
generalmente abbinato a porta occhiali

watch winder width 935 mm
with panel lacquered canna di fucile colour
to be used on top of shelf or chest of drawers
usually in combination with glass storage

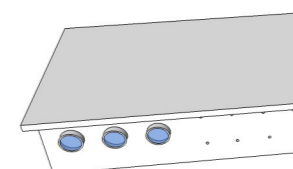

ATTREZZATURE INTERNE / INSIDE EQUIPMENT

serie standard armadi e cabine armadio / standard set for wardrobe and walk-in-closet

Attrezzature standard / Standard equipment

ripiano legno spessore 25 mm
l. 455 / 575 / 695 / 935 / 1175 / 1415 mm
ripiani speciali per angolari e terminali

wooden shelf thickness 25 mm
l. 455 / 575 / 695 / 935 / 1175 / 1415 mm
special shelves for terminal and corner

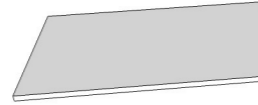

ripiano vetro extra chiaro spessore 10 mm
l. 455 / 575 / 695 / 935 mm

glass shelf extra light thickness 10 mm
l. 455 / 575 / 695 / 935 mm

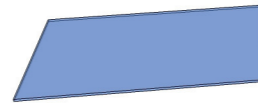

ripiano telaio in alluminio color canna di fucile
piano in vetro extra chiaro
l. 935 mm

shelf with aluminium frame canna di fucile
glass extra light plane
l. 935 mm

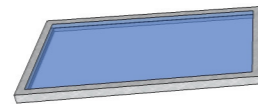

ripiano porta scarpe inclinato spessore 25 mm
profili in alluminio color canna di fucile
l. 935 mm

inclined shoes shelf thickness 25 mm
with aluminium profiles canna di fucile
l. 935 mm



ATTREZZATURE INTERNE / INSIDE EQUIPMENT

serie standard armadi e cabine armadio / standard set for wardrobe and walk-in-closet

Attrezzature standard / Standard equipment

tubo appendiabiti metallico color canna di fucile
l. 455 / 575 / 695 / 935 / 1175 / 1415 mm
tubi speciali per angolari e terminali

metallic hanging rail canna di fucile color
l. 455 / 575 / 695 / 935 / 1175 / 1415 mm
special rails for terminal and corner



servetto color marrone scuro
l. 695 / 935 mm

pull down hanging bar dark brown color
l. 695 / 935 mm



specchio applicato
l. 360 mm - h. 1700 mm
sono possibili specchi su misura

fixed mirror
l. 360 mm - h. 1700 mm
customized mirror are possible

specchio apribile
l. 360 mm - h. 1800 mm

turning mirror
l. 360 mm - h. 1800 mm

ATTREZZATURE INTERNE / INSIDE EQUIPMENT

Accessori serie LUX (solo per cabine armadio) / Fittings series LUX (only for walk-in-closet)

Strutture serie LUX / Boxes series LUX

coperchio di finitura superiore cassettiera
spessore mm 25 rovere tinto bruciato
l. mm 575 / 935

chest of drawers finishing top shelf
thickness mm 25 oak painted bruciato
l. mm 575 / 935

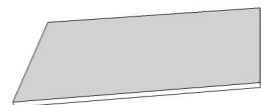

stuttura h. 240 mm rovere tinto bruciato
per inserimento 2 elementi h. 120 mm
l. mm 935

box h. 240 mm oak painted bruciato
for 2 elements h. 120 mm
l. mm 935

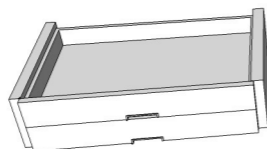

stuttura h. 280 mm rovere tinto bruciato
per inserimento 1 elemento h. 160 mm
e 1 elemento h. 120 mm
l. mm 935

box h. 280 mm oak painted bruciato
for 1 element h. 160 mm + 1 h. 120 mm
l. mm 935

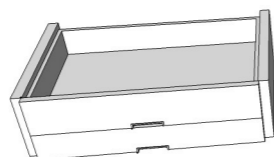

stuttura h. 320 mm rovere tinto bruciato
per inserimento 2 elementi h. 160 mm
l. mm 575 / 935

box h. 320 mm oak painted bruciato
for 2 elements h. 160 mm
l. mm 575 / 935

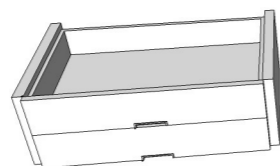

ATTREZZATURE INTERNE / INSIDE EQUIPMENT

Accessori serie LUX (solo per cabine armadio) / Fittings series LUX (only for walk-in-closet)

Inserti h. 120 mm serie LUX / Fittings h. 120 mm series LUX

vassoio sospeso estraibile in metallo
con frontale in rovere tinto bruciato
larghezza 935 mm

hanging extractable tray in metal
frontside oak veneered bruciato painted
width 935 mm

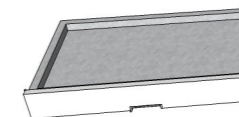

vassoio sospeso estraibile in metallo
completo di griglia divisoria
con frontale in rovere tinto bruciato
larghezza 935 mm

hanging extractable tray in metal
with partition element
frontside oak veneered bruciato painted
width 935 mm

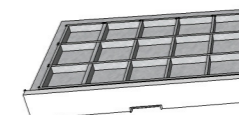

porta pantaloni sospeso estraibile
con frontale in rovere tinto bruciato
in metallo larghezza 935 mm

hanging extractable trousers hanger
frontside oak veneered bruciato painted
in metal width 935 mm

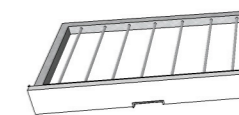

porta sacche sospeso estraibile
con frontale in rovere tinto bruciato
in metallo larghezza 935 mm

hanging extractable laundry bags
frontside oak veneered bruciato painted
in metal width 935 mm

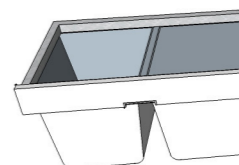

ATTREZZATURE INTERNE / INSIDE EQUIPMENT

Accessori serie LUX (solo per cabine armadio) / Fittings series LUX (only for walk-in-closet)

Inserti h. 160 mm serie LUX / Fittings h. 160 mm series LUX

cassetto legno in rovere bruciato
altezza mm 160 l. mm 575 / 935

wooden drawer oak painted bruciato
height mm 160 l. mm 575 / 935

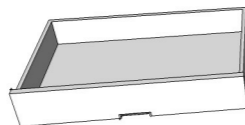

cassetto vetro cornice rovere bruciato
altezza mm 160 l. mm 935

glass drawer frame oak painted bruciato
height mm 160 l. mm 935

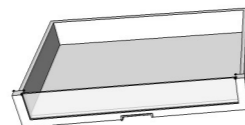

Inserti h. 320 mm serie LUX / Fittings h. 320 mm series LUX

cassettone legno in rovere bruciato
altezza mm 320 l. mm 575 / 935

wooden big drawer oak painted bruciato
height mm 320 l. mm 575 / 935

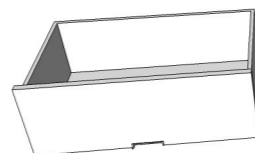

FINITURE ATTREZZATURA INTERNA / INSIDE EQUIPMENT FINISHINGS

armadi e cabine armadio / wardrobe and walk-in-closet

Attrezzatura interna / Inside equipment

1 - laccato ghiaia opaco
mat ghiaia lacquered

2 - rovere tinto tabacco
oak painted rovere tabacco

3 - rovere tinto bruciato
oak painted rovere bruciato

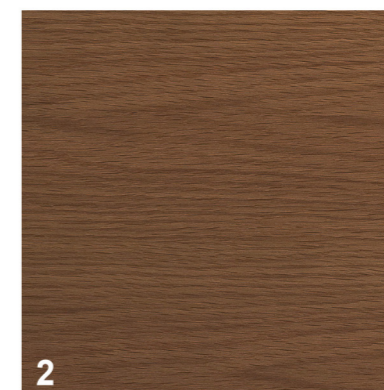

Finitura parti metalliche / Metal equipment finishing

1 - laccato canna di fucile opaco
mat canna di fucile lacquered



WARDROBE

leaf doors / sliding doors / coplanar doors



COMPONENTI STRUTTURALI / STRUCTURE COMPONENTS

armadi e cabine armadio / wardrobe and walk-in-closet

Componenti / Components

- 1 - spalla laterale
end side
- 2 - spalla centrale
middle side
- 3 - coperchio
top shelf
- 4 - basamento
bottom shelf
- 5 - schienale
back panel

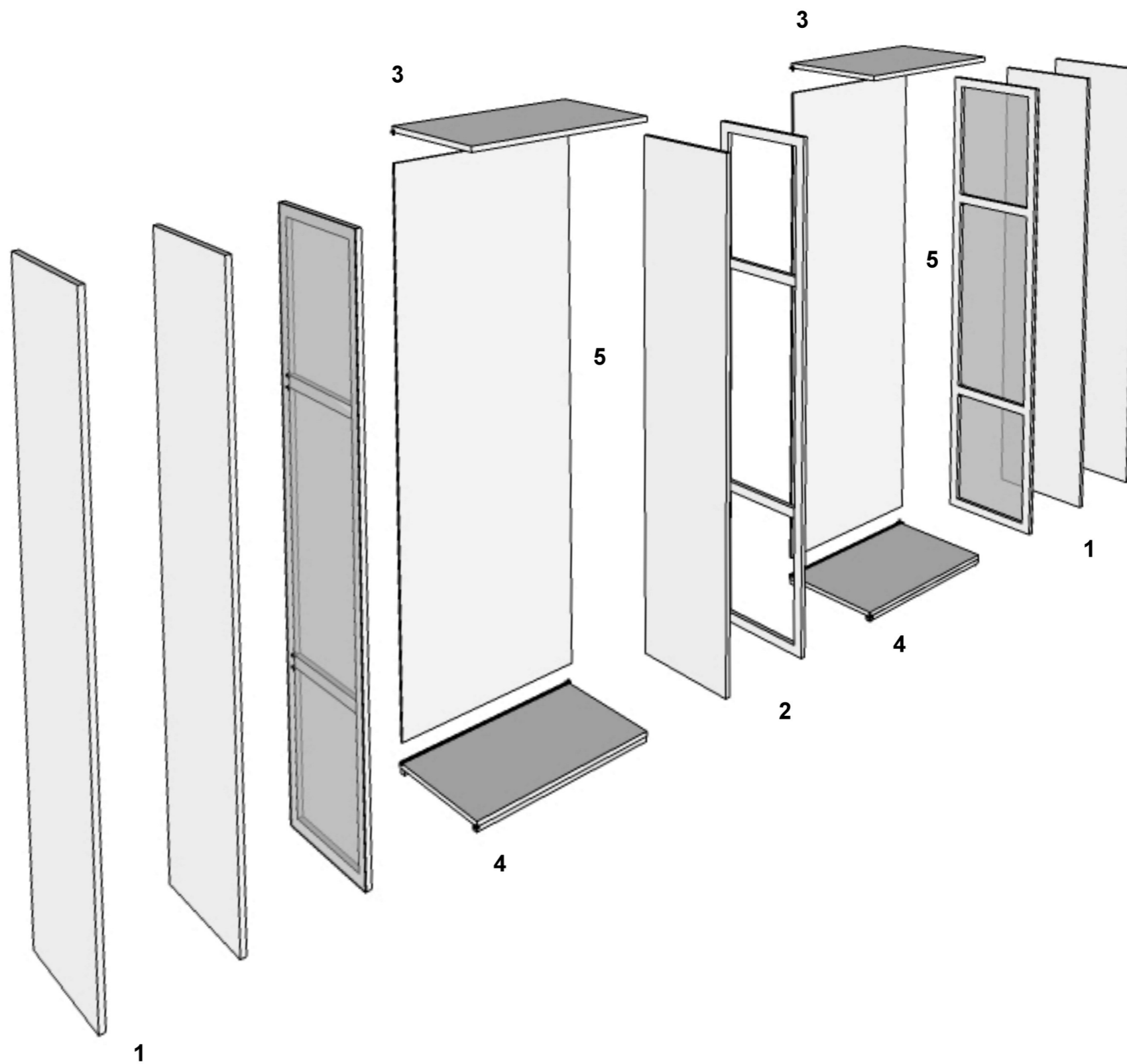

COMPONENTI STRUTTURALI / STRUCTURE COMPONENTS

armadi e cabine armadio / wardrobe and walk-in-closet

Tipologie fianchi / Sides types

1 - spalla esterna armadio spessore mm 25
lato esterno rovere tinto / rovere laccato / laccato
h. mm 2265 - 2585 - 2905 profondità mm 570

wardrobe external side thickness mm 25
outside painted oak / lacquered oak / lacquered
h. mm 2265 - 2585 - 2905 depht mm 570

2 - spalla esterna armadio spessore mm 27
lato esterno rivestito pelle / ecopelle
h. mm 2265 - 2585 - 2905 profondità mm 570

wardrobe external side thickness mm 27
outside leather / ecoleather covered
h. mm 2265 - 2585 - 2905 depht mm 570

3 - spalla esterna vetro armadio spessore mm 29
lato esterno vetro applicato
h. mm 2585 profondità mm 570

wardrobe external side thickness mm 29
outside glass covered
h. mm 2585 depht mm 570

4 - spalla interna armadio / cabina spessore mm 25
rovere tinto tabacco / laccato ghiaia
h. mm 2265 - 2585 - 2905 profondità mm 570

wardrobe / walk-in-closet side thickness mm 25
painted oak rovere tabacco / ghiaia lacquered
h. mm 2265 - 2585 - 2905 depht mm 570

5 - spalla armadio interna telaio spessore mm 25
alluminio laccato canna di fucile
h. mm 2585 profondità mm 570

wardrobe middle frame side thickness mm 25
aluminium canna di fucile lacquered
h. mm 2585 depht mm 570

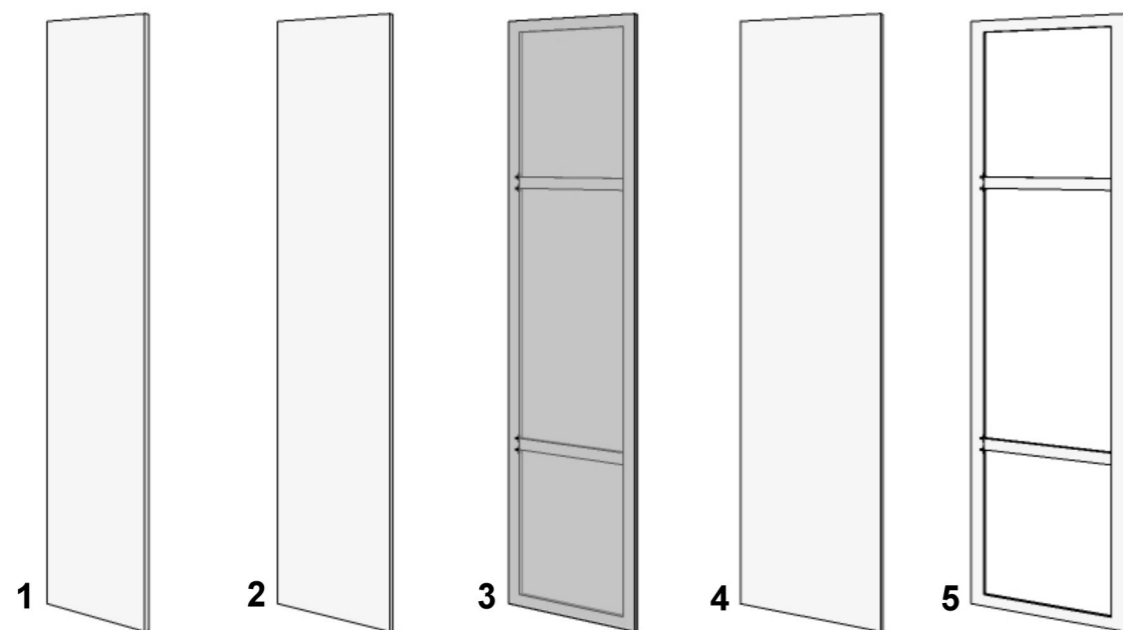

COMPONENTI STRUTTURALI / STRUCTURE COMPONENTS

armadi e cabine armadio / wardrobe and walk-in-closet

Tipologia schienali / Back panel types

1 - schienale armadio / cabina spessore mm 9
lato interno rovere tinto tabacco / laccato ghiaia
h. mm 2265 - 2585 - 2905
l. mm 465 - 585 - 945

wardrobe / walk-in-closet backpanel thickness mm 9
innerside painted rovere tabacco oak / ghiaia lacquered
h. mm 2265 - 2585 - 2905
l. mm 465 - 585 - 945

2 - schienale armadio / cabina spessore mm 10
lato interno rivestito pelle / ecopelle
h. mm 2265 - 2585 - 2905
l. mm 465 - 585 - 945

wardrobe / walk-in-closet backpanel thickness mm 10
innerside leather / ecoleather covered
h. mm 2265 - 2585 - 2905
l. mm 465 - 585 - 945

3 - schienale armadio / cabina spessore mm 20
lato interno rovere tinto tabacco / laccato ghiaia
h. mm 2265 - 2585 - 2905
l. mm 1185 - 1425

wardrobe / walk-in-closet backpanel thickness mm 20
innerside painted rovere tabacco oak / ghiaia lacquered
h. mm 2265 - 2585 - 2905
l. mm 1185 - 1425

4 - schienale armadio / cabina spessore mm 21
lato interno rivestito pelle / ecopelle
h. mm 2265 - 2585 - 2905
l. mm 1185 - 1425

wardrobe / walk-in-closet backpanel thickness mm 21
innerside leather / ecoleather covered
h. mm 2265 - 2585 - 2905
l. mm 1185 - 1425

5 - schienale vetro armadio (solo con spalle alluminio)
h. mm 2585
l. mm 465 - 945

wardrobe glass backpanel (only with aluminium side)
h. mm 2585
l. mm 465 - 945

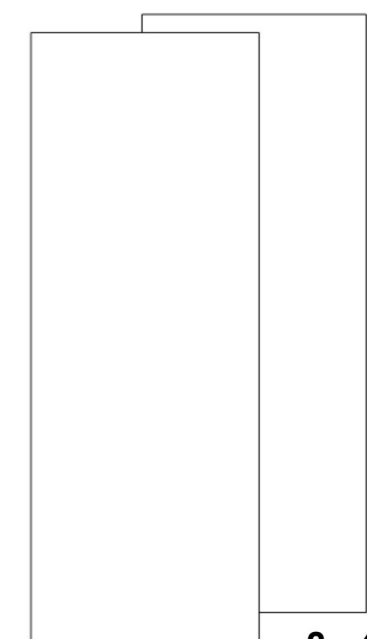

1 - 3

2 - 4

COMPONENTI STRUTTURALI / STRUCTURE COMPONENTS

armadi e cabine armadio / wardrobe and walk-in-closet

Tipologia ripiani / Shelves types

- 1** - ripiano armadio / cabina spessore mm 25
rovere tinto tabacco / laccato ghiaia
l. mm 455 - 575 - 695 - 935 - 1175 - 1415

wardrobe / walk-in-closet shelf thickness mm 25
oak painted rovere tabacco / ghiaia lacquered
l. mm 455 - 575 - 695 - 935 - 1175 - 1415



- 2** - ripiano armadio / cabina spessore mm 40
laccato ghiaia
l. mm 455 - 575 - 695 - 935 - 1175 - 1415

wardrobe / walk-in-closet shelf thickness mm 40
ghiaia lacquered
l. mm 455 - 575 - 695 - 935 - 1175 - 1415



- 3** - ripiano armadio / cabina spessore mm 10
vetro extrachiaro
l. mm 455 - 575 - 935

wardrobe / walk-in-closet shelf thickness mm 10
glass extralight
l. mm 455 - 575 - 935



- 4** - ripiano armadio / cabina in vetro
con telaio alluminio verniciato canna di fucile
l. mm 935

wardrobe / walk-in-closet glass shelf
with aluminium frame canna di fucile painted
l. mm 935



MODULARITA' STRUTTURA / STRUCTURE MODULARITY

armadi a battente / leaf wardrobe

Modularità / Modularity

- 1** - struttura a 1 anta 480 mm
(ripiano 455 mm + spalla 25 mm)
structure for 1 door 480 mm
(shelf 455 mm + side 25 mm)

- 2** - struttura a 1 anta 600 mm
(ripiano 575 mm + spalla 25 mm)
structure for 1 door 600 mm
(shelf 575 mm + side 25 mm)

- 3** - struttura a 2 ante 480 mm
(ripiano 935 mm + spalla 25 mm)
structure for 2 doors 480 mm
(shelf 935 mm + side 25 mm)

- 4** - struttura a 2 ante 600 mm
(ripiano 1175 mm + spalla 25 mm)
structure for 2 doors 600 mm
(shelf 1175 mm + side 25 mm)

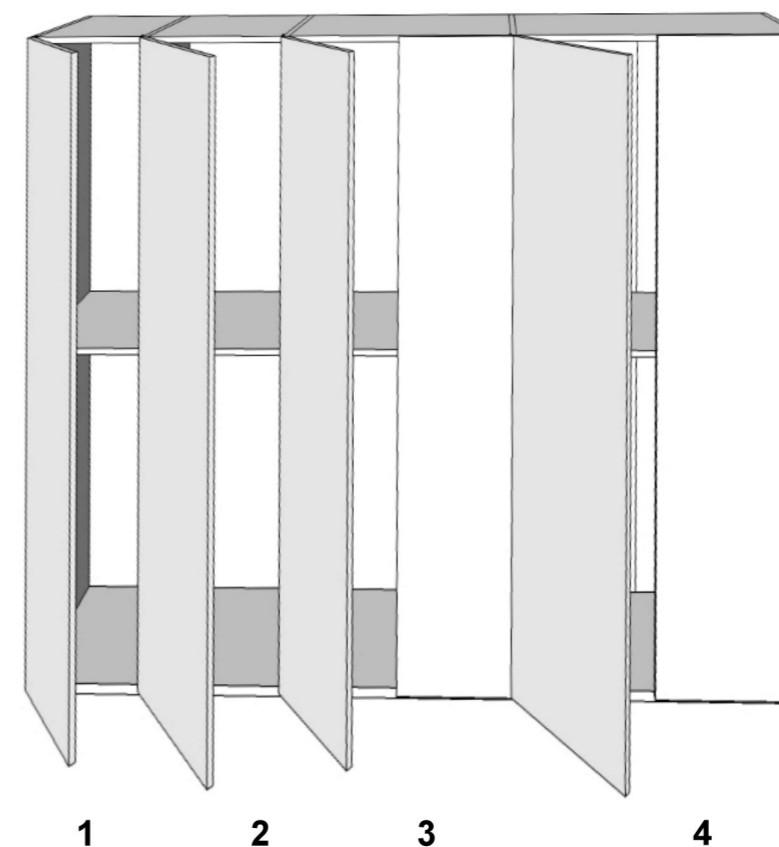

MODULARITA' STRUTTURA / STRUCTURE MODULARITY

armadio complanare / coplanar wardrobe

Modularità / Modularity

- 1 - struttura a 1 anta 1440 mm
(ripiano 1415 mm + spalla 25 mm)
structure for 1 door 1440 mm
(shelf 1415 mm + side 25 mm)

N.B. negli armadi complanari devono esserci almeno 2 strutture
le strutture devono essere in numero pari

coplanar wardrobe must have at least 2 structures
structures have to be even number

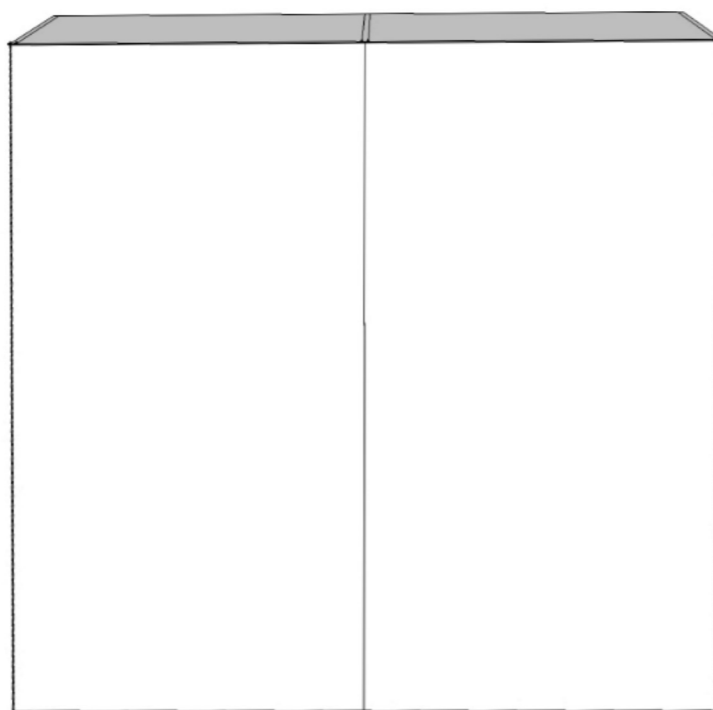

1

MODULARITA' STRUTTURA / STRUCTURE MODULARITY

armadio scorrevole / sliding wardrobe

Modularità / Modularity

- 1 - struttura a 1 anta 720 mm
(ripiano 695 mm + spalla 25 mm)
structure for 1 door 720 mm
(shelf 695 mm + side 25 mm)

- 2 - struttura a 1 anta 960 mm
(ripiano 935 mm + spalla 25 mm)
structure for 1 door 960 mm
(shelf 935 mm + side 25 mm)

- 3 - struttura a 1 anta 1200 mm
(ripiano 1175 mm + spalla 25 mm)
structure for 1 door 1200 mm
(shelf 1175 mm + side 25 mm)

- 4 - struttura a 1 anta 1440 mm
(ripiano 1415 mm + spalla 25 mm)
structure for 1 door 1440 mm
(shelf 1415 mm + side 25 mm)

N.B. negli armadi scorrevoli devono esserci almeno 2 strutture
strutture di misure diverse possono essere affiancate con limitazioni di attrezzatura interna
affiancando strutture di diverse misure l'apertura della porta può essere parziale

sliding wardrobe must have at least 2 structures
different size structures can be joint with inside equipment restriction
while putting different size doors opening can be incomplete

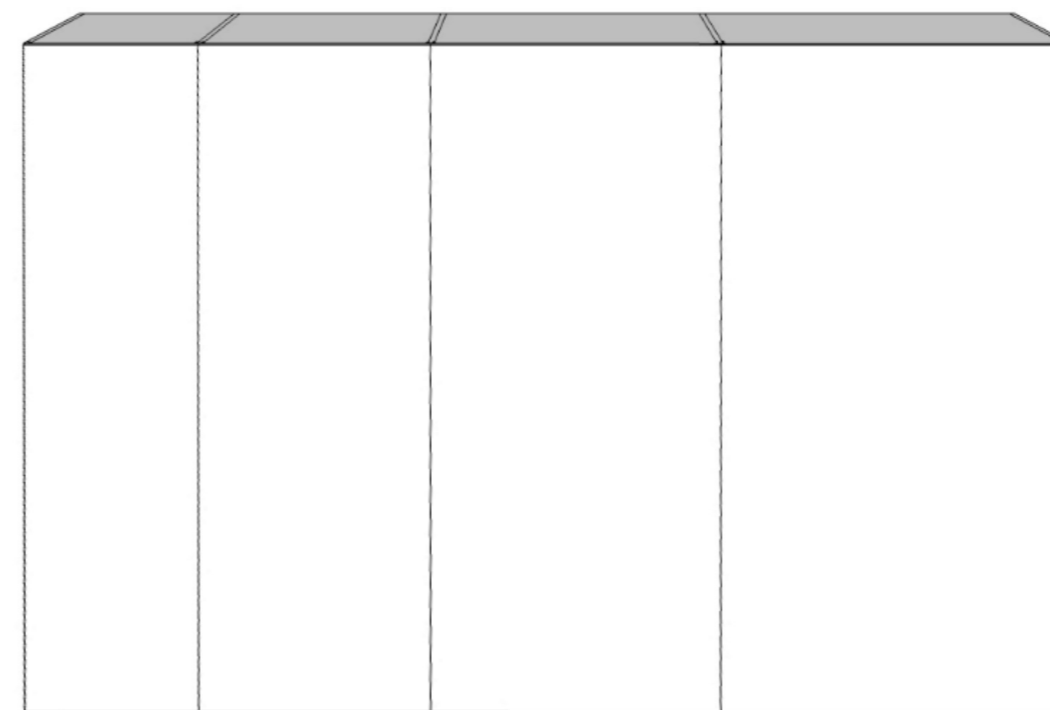

1

2

3

4

TIPOLOGIE DI APERTURA / OPENING TYPOLOGIES

armadio / wardrobe

Ante a battente / Leaf doors

tutte le ante a battente sono fornite di serie con cerniere ammortizzate

all leaf doors are supplied as standard with soft closing hinges

tipo / types

Wood
Basic
Astor
Skin
Beta
Futura
Color
Halfa
Level
Plumb

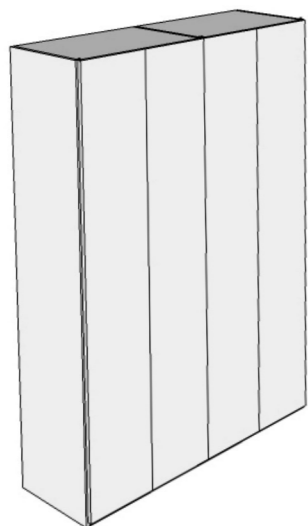

Ante scorrevoli / Sliding doors

tutte le ante scorrevoli sono fornite di serie con sistema di scorrimento ammortizzato

all sliding doors are supplied as standard with soft closing system

tipo / types

Basic
Skin
Beta
Futura
Color
Tris
Level
Plumb

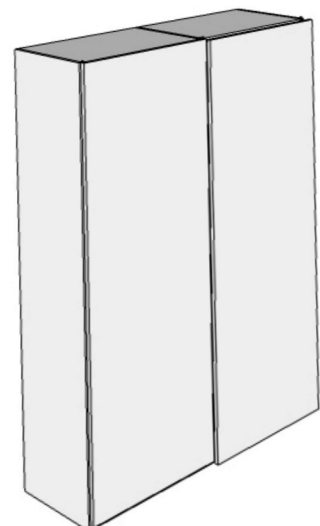

Ante complanari / Coplanar doors

tutte le ante complanari sono fornite di serie con sistema di scorrimento ammortizzato

all coplanar doors are supplied as standard with soft closing system

tipo / types

Skin
Tris
Level

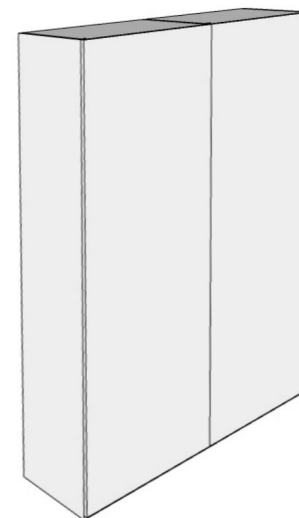

Cassetti / Drawers

tutti i cassetti esterni sono forniti con guide di scorrimento metalliche (abbinabili solo a ante a battente)

all drawers are supplied with metallic sliding system (to be used only with leaf doors)

tipo / types

Wood
Basic
Skin

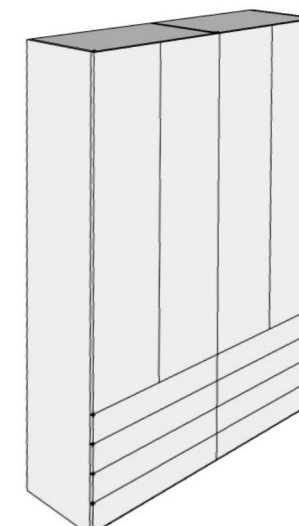

FINITURA STRUTTURA / STRUCTURE FINISHINGS

armadio / wardrobe

Componenti strutturali / Structure components

1 - laccato ghiaia opaco
mat ghiaia lacquered

2 - rovere tinto tabacco
oak painted rovere tabacco



Attrezzatura interna/ Inside equipment

1 - laccato ghiaia opaco
mat ghiaia lacquered

2 - rovere tinto tabacco
oak painted rovere tabacco



FORATURA FIANCHI / SIDES DRILLING

armadi e cabine armadio / wardrobe and walk-in-closet

Forature di serie / Standard drillings

1 - fianco senza fori
side without holes

2 - foratura passo 320 mm
1 hole pitch 320 mm

3 - gruppo 3 fori passo 320 mm
3 holes pitch 320 mm

4 - foratura continua passo 64 mm
continuous drilling pitch 64 mm

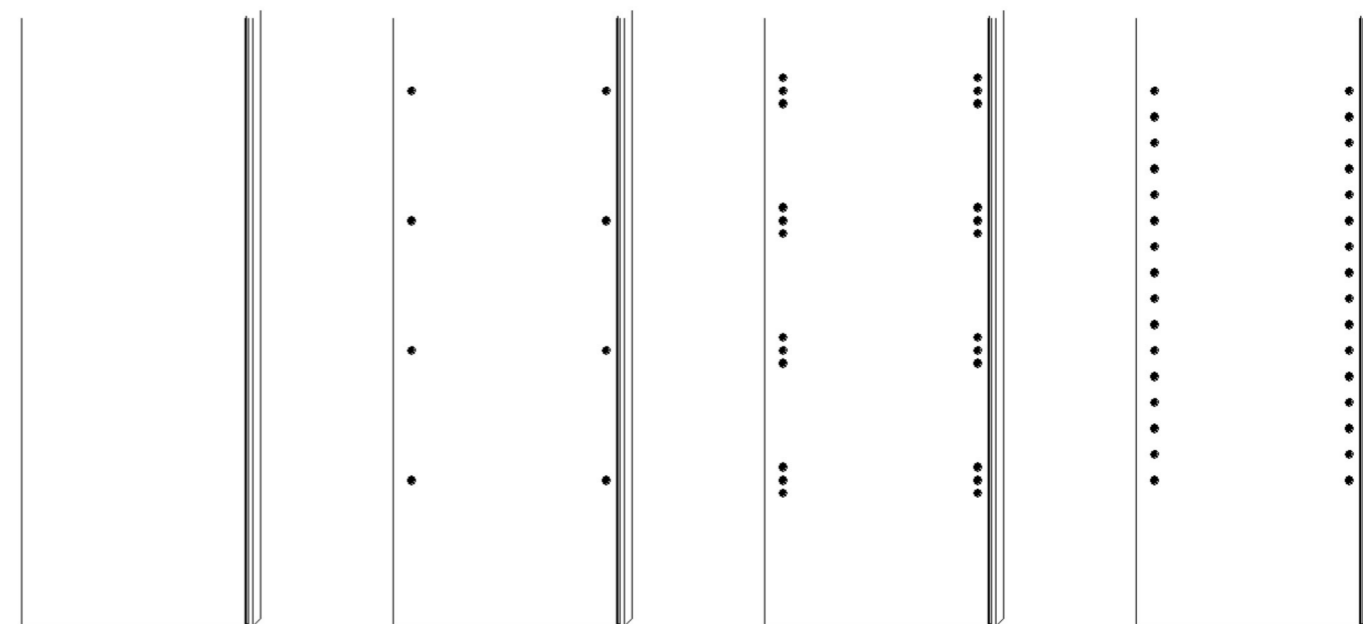

1

2

3

4

NB - è possibile richiedere forature personalizzate
se nulla è specificato sui fianchi verrà applicata la foratura 2
it is possible to have custom drilling
without specification drilling 2 will be made

FERRAMENTA APERTURA / OPENING HARDWARE

armadio ante battente / leaf door wardrobe

Cerniera / Hinge

cerniere in metallo
per tutte le ante a battente escluso beta e halfa
apertura di serie 95° opzionale 180°

hinge in metal
for all leaf doors except beta and halfa
standard opening 95° optional 180°



Cerniera Beta / Hinge Beta

cerniera in metallo verniciata canna di fucile
per ante a battente beta
apertura di serie 180°

hinge in metal mat canna di fucile painted
for leaf doors beta
standard opening 180°



Cerniere Halfa / Hinge Halfa

cerniera in metallo
per ante a battente halfa
apertura di serie 95°

hinge in metal
for leaf doors halfa
standard opening 95°

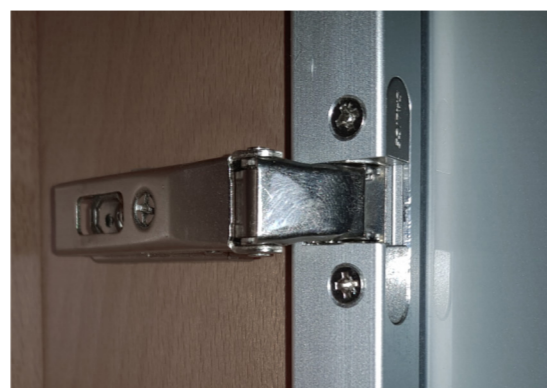

FERRAMENTA APERTURA / OPENING HARDWARE

armadio scorrevole o complanare e cassetti / sliding or coplanar wardrobe and drawers

Anta scorrevole / Sliding door

ferramenta metallica
per ante scorrevoli
con chiusura ammortizzata

metallic hardware
for all sliding doors
with soft closing

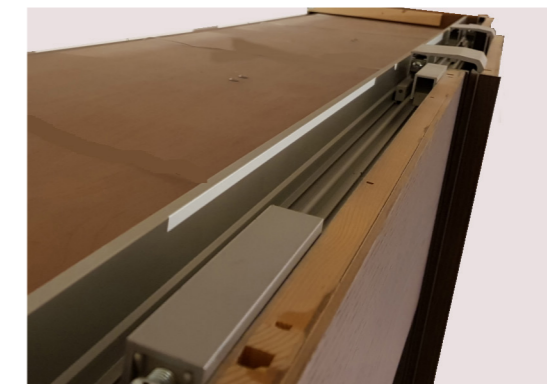

Anta complanare / Coplanar door

ferramenta metallica
per ante complanari
con chiusura ammortizzata

metallic hardware
for all coplanar doors
with soft closing

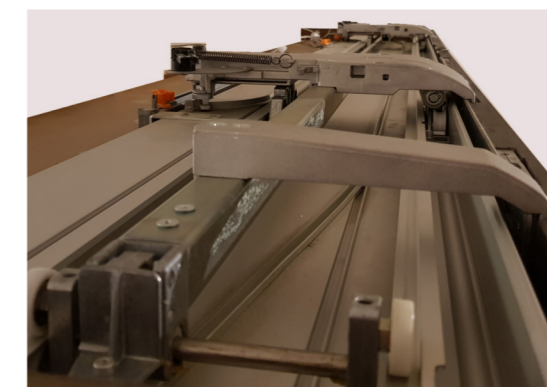

Cassetti / Drawers

ferramenta metallica
per cassetti
con chiusura ammortizzata

metallic hardware
for drawers
with soft closing



ILLUMINAZIONE / LIGHTING

armadi e cabine armadio / wardrobe and walk-in-closet

Lampada led incassata ripiano legno Led lamp built-in in wooden shelf

lampada led a luce naturale 4000 K

- 1 accensione tramite collegamento a presa comandata
- 2 accensione con radiocomando a distanza
- 3 accensione tramite sensore ad apertura anta (escluse ante beta e halfa)

led lamp with natural light 4000 K

- 1 switch connected with controlled socket
- 2 switch with remote controller
- 3 automatic switch at door opening (not for door beta and halfa)

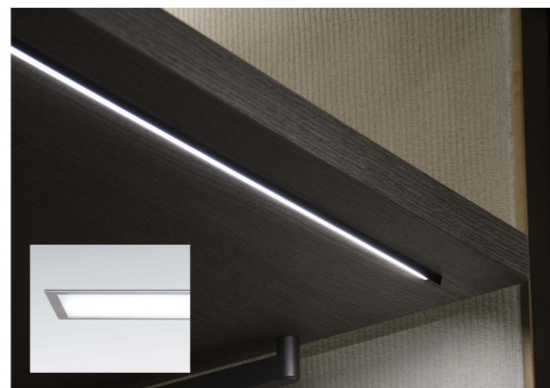

Striscia led incassata fianco legno Led stripe built-in wooden side

lampada led a luce naturale 4000 K

- 1 accensione tramite collegamento a presa comandata
- 2 accensione con radiocomando a distanza

led lamp with natural light 4000 K

- 1 switch connected with controlled socket
- 2 switch with remote controller

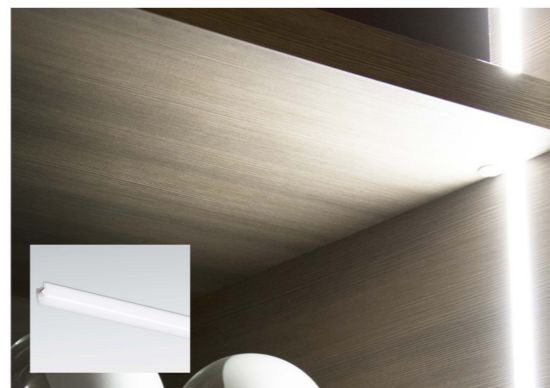

Faretti led da incasso Built-in led spot light

lampada led a luce naturale 4000 K

- 1 accensione tramite collegamento a presa comandata
- 2 accensione con radiocomando a distanza

led lamp with natural light 4000 K

- 1 switch connected with controlled socket
- 2 switch with remote controller



ILLUMINAZIONE / LIGHTING

armadi e cabine armadio / wardrobe and walk-in-closet

1 Accensione tramite collegamento a presa comandata Switch connected with controlled socket

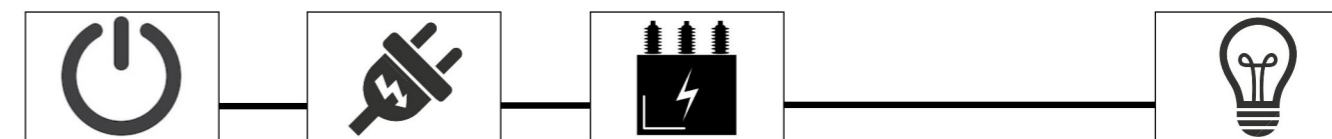

interruttore
switch

spina controllata
controlled socket

trasformatore
power trasformer

luce led
led light

2 Accensione con radiocomando a distanza Switch with remote controller

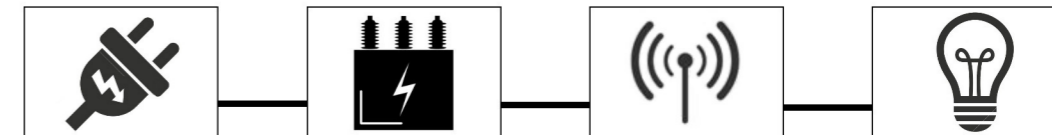

spina
socket

trasformatore
power trasformer

centralina
radiocomando
remote control
unit

luce led
led light

3 Accensione tramite sensore ad apertura anta Automatic switch at door opening

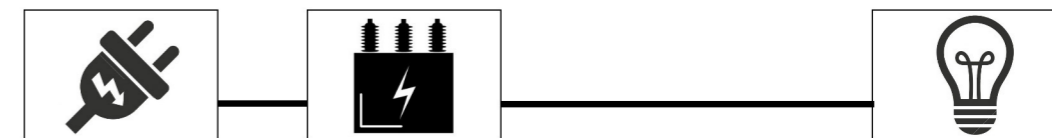

spina
socket

trasformatore
power trasformer

luce led
led light

SOLUZIONI SPECIALI / SPECIAL SOLUTIONS

armadio / wardrobe

Combinazione ante / Doors combine

- 1 - ante battente e ante scorrevole
leaf doors and sliding doors

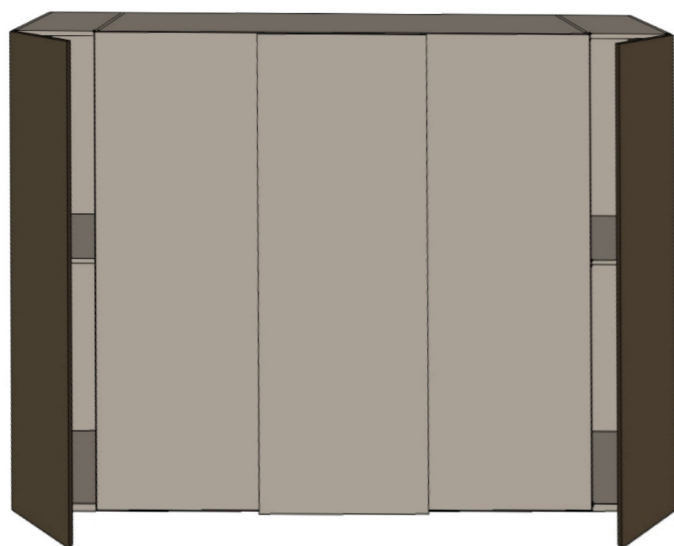

- 2 - ante battente e ante complanari
leaf doors and coplanar doors

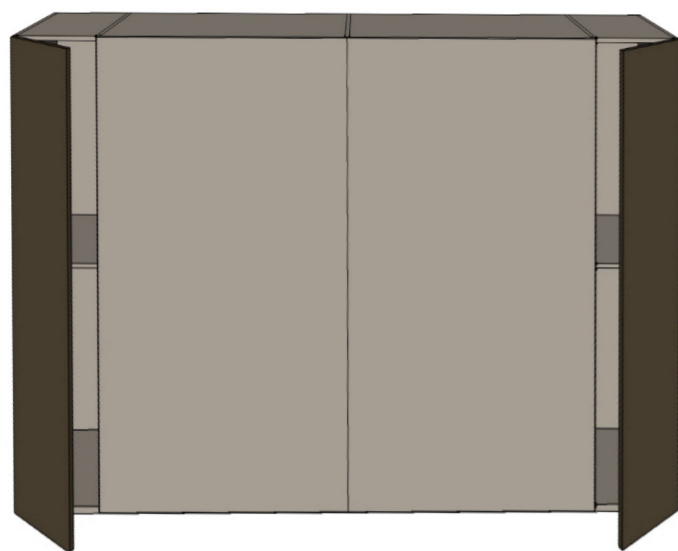

SOLUZIONI SPECIALI / SPECIAL SOLUTIONS

armadio / wardrobe

Soluzioni angolari / Corner solutions

- 1 - elemento angolare
ante a battente l. 480 mm (escluso beta e halfa)
h. 2265 / 2585 / 2905 mm
apertura a 180°

corner element
leaf doors l. 480 mm (except beta and halfa)
h. 2265 / 2585 / 2905 mm
opening 180 degrees

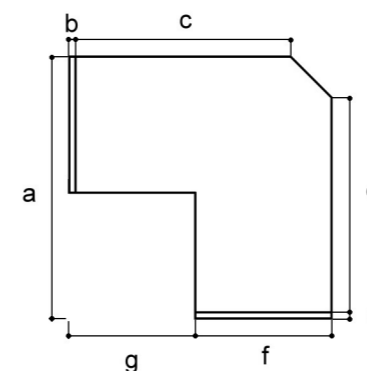

a : 1095 mm
b : 25 mm
c : 900 mm
d : 900 mm
e : 25 mm
f : 570 mm
g : 500 mm

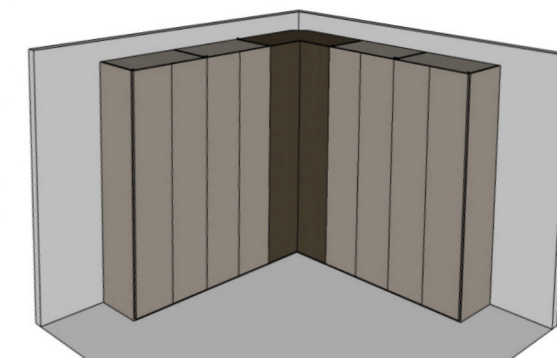

- 2 - angolo cieco con sagoma
qualunque tipo di anta
h. 2265 / 2585 / 2905 mm

closed corner element with profile
all kind of doors
h. 2265 / 2585 / 2905 mm

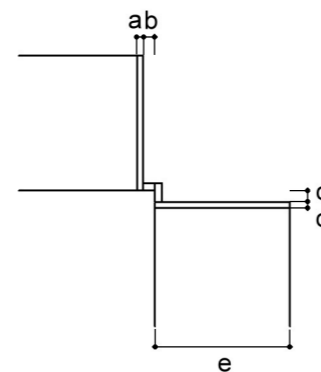

a : 25 mm
b : 50 mm
c : 50 mm
d : 25 mm
e : 570 mm

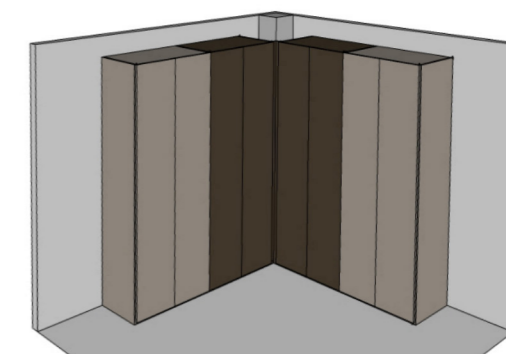

SOLUZIONI SPECIALI / SPECIAL SOLUTIONS

armadio / wardrobe

Soluzioni terminali / Terminal solution

- 1 - elemento terminale
 ante a battente l. 480 mm (escluso beta e halfa)
 h. 2265 / 2585 / 2905 mm

terminal element
 leaf door l. 480 mm (except beta and halfa)
 h. 2265 / 2585 / 2905 mm

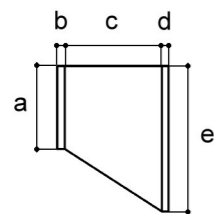

a : 325 mm
 b : 30 mm
 c : 380 mm
 d : 25 mm
 e : 570 mm

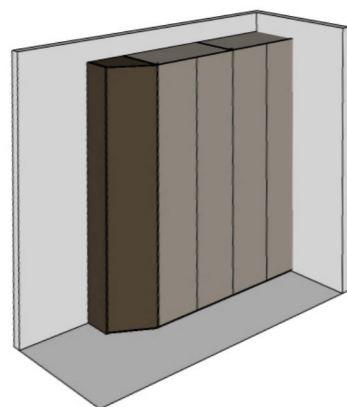

SOLUZIONI SPECIALI / SPECIAL SOLUTIONS

armadio / wardrobe

Angoli spogliatoio / Dressing corner

- 2 - angolo spogliatoio terminale a 2 ante
 ante a battente l. 480 mm (escluso beta e halfa)
 h. 2265 / 2585 / 2905 mm

2 doors terminal dressing corner
 leaf doors l. 480 mm (except beta and halfa)
 h. 2265 / 2585 / 2905 mm

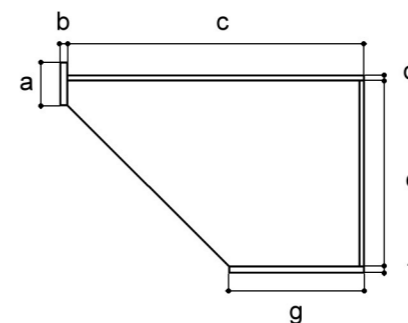

a : 205 mm
 b : 30 mm
 c : 1255 mm
 d : 20 mm
 e : 790 mm
 f : 25 mm
 g : 570 mm

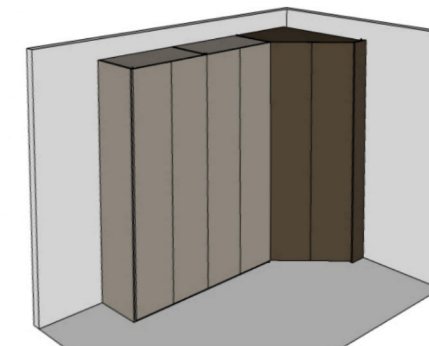

Angoli spogliatoio / Dressing corner

- 1 - angolo spogliatoio tra armadi
 ante a battente l. 480 mm (escluso beta e halfa)
 h. 2265 / 2585 / 2905 mm

dressing corner between wardrobes
 leaf doors l. 480 mm (except beta and halfa)
 h. 2265 / 2585 / 2905 mm

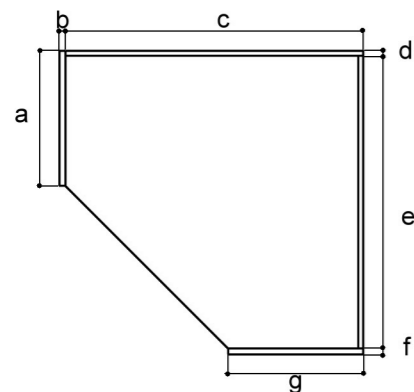

a : 570 mm
 b : 25 mm
 c : 1255 mm
 d : 20 mm
 e : 1235 mm
 f : 20 mm
 g : 570 mm

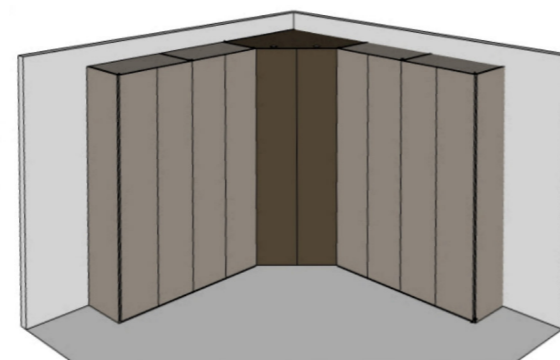

- 3 - angolo spogliatoio terminale a 3 ante
 ante a battente l. 480 mm (escluso beta e halfa)
 h. 2265 / 2585 / 2905 mm

3 doors terminal dressing corner
 leaf doors l. 480 mm (except beta and halfa)
 h. 2265 / 2585 / 2905 mm

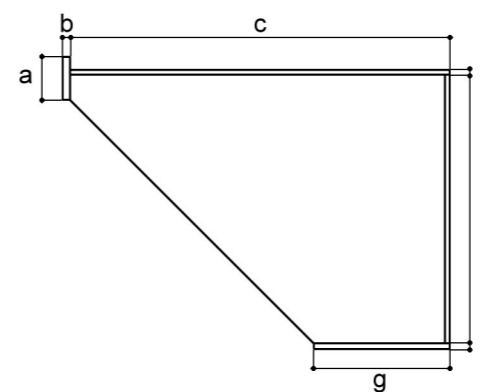

a : 205 mm
 b : 30 mm
 c : 1590 mm
 d : 20 mm
 e : 1130 mm
 f : 25 mm
 g : 570 mm

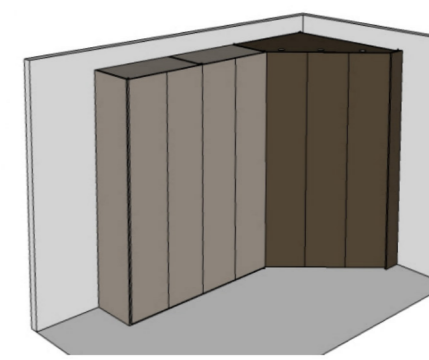

SOLUZIONI SPECIALI / SPECIAL SOLUTIONS

armadio / wardrobe

Anta ripostiglio / Openable side door

- 1 - anta a battente (escluso beta e halfa)
l. 480 / 600 mm anche ridotte a misura
h. 2265 / 2585 / 2905 mm

leaf door (except beta and halfa)
l. 480 / 600 mm even reduced on size
h. 2265 / 2585 / 2905 mm

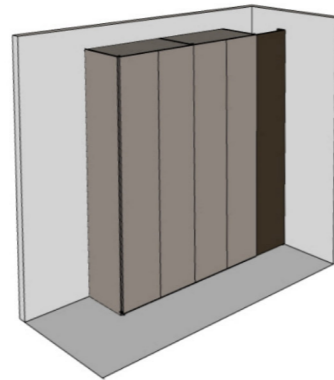

Armadi a mansarda / Wardrobe under the roof

- 1 - ante a battente wood / basic / astor / skin / plumb
l. 480 / 600 mm anche ridotte a misura
h. con taglio in diagonale

leaf door wood / basic / astor / skin / plumb
l. 480 / 600 mm even reduced on size
h. diagonally cutted

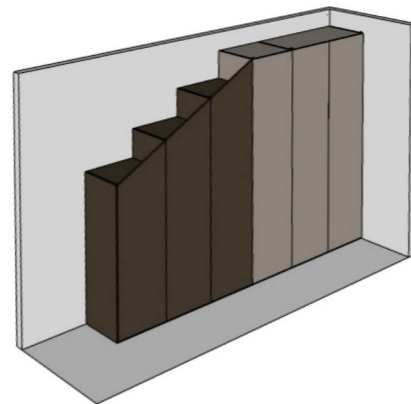

SOLUZIONI SPECIALI / SPECIAL SOLUTIONS

armadio / wardrobe

Ponte passaggio porta / Bridge door passage

- 1 - anta a battente wood / basic / astor / skin / plumb
possibilità di taglio a misura

leaf door wood / basic / astor / skin / plumb
customize possibility

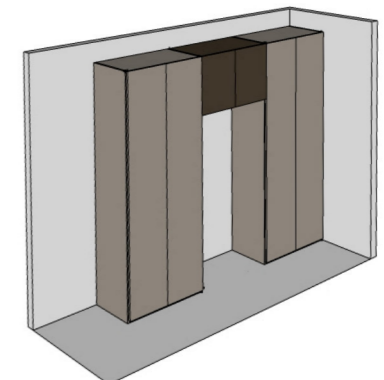

Fascia di tamponamento / Filler

- 1 - tamponamento laterale
tamponamento superiore (solo armadi a battente e cabine armadio)

lateral filler
upper filler (only leaf wardrobe and walk-in-closet)

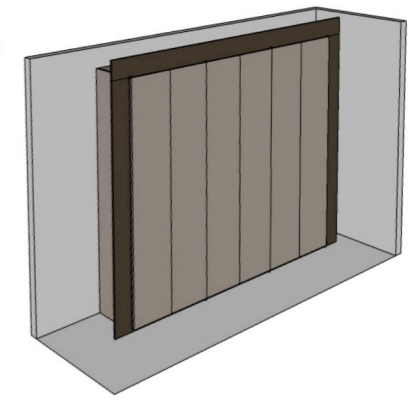

ATTREZZATURE INTERNE / INSIDE EQUIPMENT

armadi e cabine armadio / wardrobe and walk-in-closet

Esempi organizzazione colonne / Inner organization examples

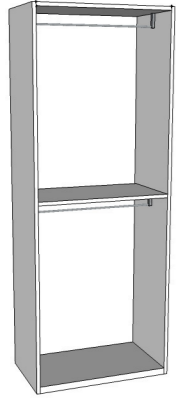

1 ripiano
2 tubi appendiabiti

1 shelf
2 hanging rails

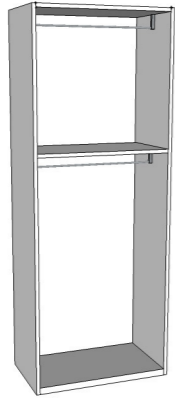

1 ripiano
2 tubi appendiabiti

1 shelf
2 hanging rails

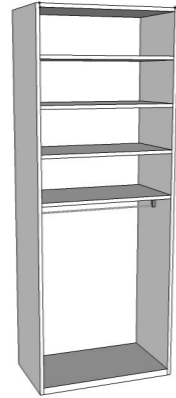

4 ripiani
1 tubo appendiabiti

4 shelves
1 hanging rail

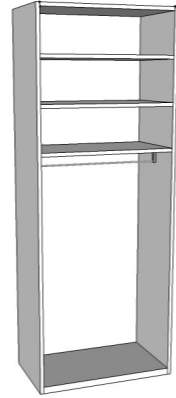

3 ripiani
1 tubo appendiabiti

3 shelves
1 hanging rail



4 ripiani
2 cassetti legno

4 shelves
2 wooden drawers

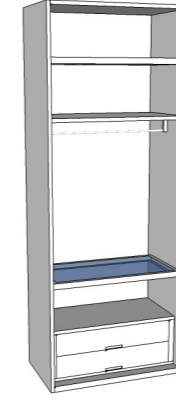

2 ripiani legno
1 ripiano vetro
2 cassetti legno
1 tubo appendiabiti

2 wooden shelves
1 glass shelf
2 wooden drawers
1 hanging rail

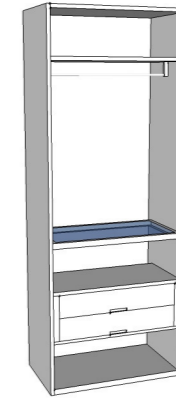

1 ripiano legno
1 ripiano vetro
2 cassetti legno
1 tubo appendiabiti

1 wooden shelf
1 glass shelf
2 wooden drawers
1 hanging rail

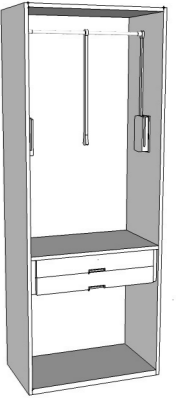

1 servetto
1 vassoio metallo
1 vassoio metallo
con divisorio

1 servetto
1 metallic tray
1 metallic tray
with divider

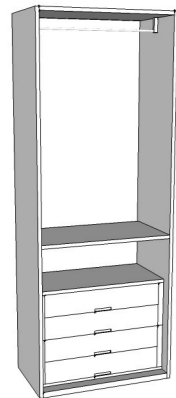

1 ripiano
4 cassetti legno
1 tubo appendiabiti

1 shelf
4 wooden drawers
1 hanging rail

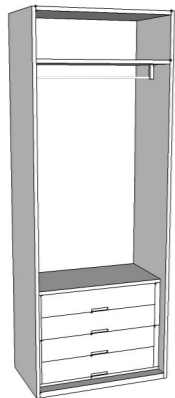

1 ripiano
4 cassetti legno
1 tubo appendiabiti

1 shelf
4 wooden drawers
1 hanging rail

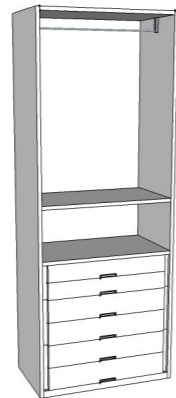

1 ripiano
6 cassetti legno
1 tubo appendiabiti

1 shelf
6 wooden drawers
1 hanging rail

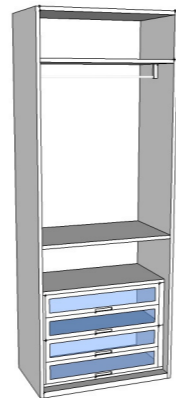

1 ripiano
4 cassetti vetro
1 tubo appendiabiti

1 shelf
4 glass drawers
1 hanging rail

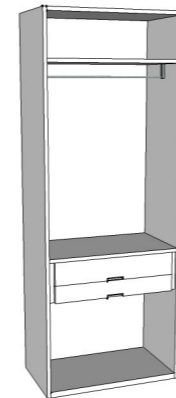

1 ripiano legno
1 cassetto legno
1 vassoio metallo
1 tubo appendiabiti

1 wooden shelf
1 wooden drawer
1 metallic tray
1 hanging rail

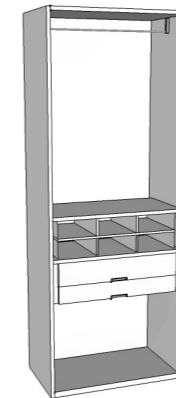

1 cassetto legno
1 vassoio metallo
1 porta camice
1 tubo appendiabiti

1 wooden drawer
1 metallic tray
1 shirt storage
1 hanging rail

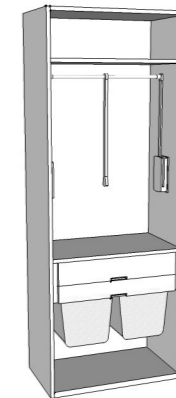

1 ripiano legno
1 cassetto legno
1 porta sacche
1 servetto

1 wooden shelf
1 wooden drawer
1 laundry bags
1 servetto

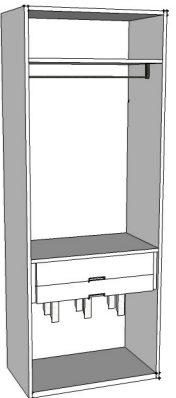

1 ripiano legno
1 cassetto legno
1 vassoio metallo
1 porta stivali
1 tubo appendiabiti

1 wooden shelf
1 wooden drawer
1 metallic tray
1 boots tray
1 hanging rail

ATTREZZATURE INTERNE / INSIDE EQUIPMENT

armadi e cabine armadio / wardrobe and walk-in-closet

Esempi organizzazione colonne / Inner organization examples

ATTREZZATURE INTERNE / INSIDE EQUIPMENT

armadi e cabine armadio / wardrobe and walk-in-closet

Esempi organizzazione colonne / Inner organization examples

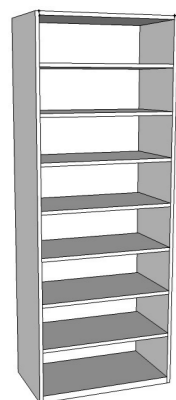

7 ripiani legno
7 wooden shelves

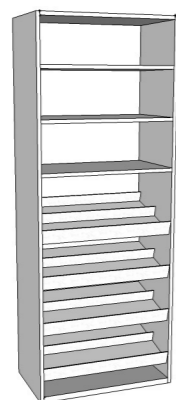

3 ripiani legno
4 porta scarpe
3 wooden shelves
4 shoes shelves

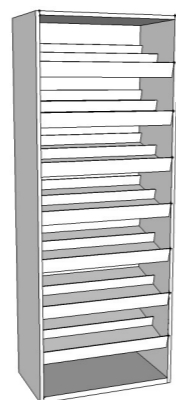

7 porta scarpe
7 shoes shelves

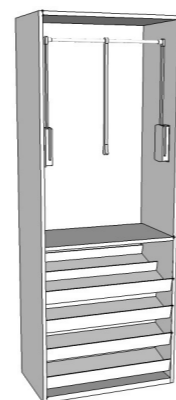

1 ripiano legno
4 porta scarpe
1 servetto
1 wooden shelf
4 shoes shelves
1 servetto

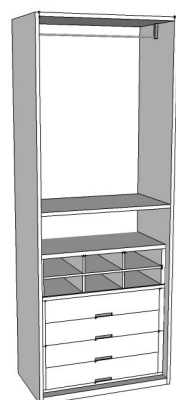

1 ripiano legno
4 cassetti legno
1 porta camice
1 tubo appendiabiti
1 wooden shelf
4 wooden drawers
1 shirt storage
1 hanging rail



2 ripiani vetro
6 cassetti legno
1 porta camice
2 glass shelves
6 wooden drawers
1 shirt storage

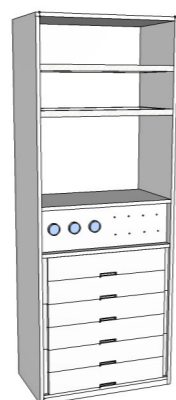

2 ripiani vetro
6 cassetti legno
1 porta occhiali
3 porte orologi
2 glass shelves
6 wooden drawers
1 glass storage
3 watch winder

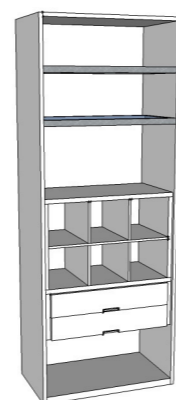

2 ripiani vetro
2 cassetti legno
1 porta borse
2 glass shelves
2 wooden drawers
1 bag storage

ATTREZZATURE INTERNE / INSIDE EQUIPMENT

serie standard armadi e cabine armadio / standard set for wardrobe and walk-in-closet

Cassettiere / Chest of drawers



1 - coperchio di finitura superiore cassetiera
spessore mm 25 rovere tinto tabacco / laccato ghiaia
l. mm 455 - 575 - 695 - 935 - 1175 - 1415

chest of drawers finishing top shelf
thickness mm 25 oak painted tabacco / ghiaia lacquered
l. mm 455 - 575 - 695 - 935 - 1175 - 1415

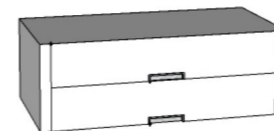

2 - elemento a 2 cassetti legno
altezza mm 320 rovere tinto tabacco / laccato ghiaia
l. mm 455 - 575 - 695 - 935

2 wooden drawers unit
height mm 320 oak painted tabacco / ghiaia lacquered
l. mm 455 - 575 - 695 - 935



3 - elemento a 1 cassettone legno
altezza mm 320 rovere tinto tabacco / laccato ghiaia
l. mm 455 - 575 - 695 - 935

1 wooden big drawer unit
height mm 320 oak painted tabacco / ghiaia lacquered
l. mm 455 - 575 - 695 - 935

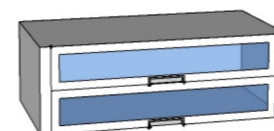

4 - elemento a 2 cassetti vetro
altezza mm 320 rovere tinto tabacco / laccato ghiaia
l. mm 935

2 glass drawers unit
height mm 320 oak painted tabacco / ghiaia lacquered
l. mm 935



5 - basamento per cassetiera
spessore mm 20 rovere tinto tabacco / laccato ghiaia
l. mm 455 - 575 - 695 - 935

2 chest of drawers bottom
thickness mm 20 oak painted tabacco / ghiaia lacquered
l. mm 455 - 575 - 695 - 935

ATTREZZATURE INTERNE / INSIDE EQUIPMENT

serie standard armadi e cabine armadio / standard set for wardrobe and walk-in-closet

Cassettiere / Chest of drawers

cassettiere a terra e cassettiere sospese
con cassetti legno larghezza 455 mm
altezza 365 mm per modulo base a 2 cassetti
+ 320 mm per ogni modulo aggiuntivo

freestanding and hanging chest of drawers
with wooden drawers width 455 mm
height 365 mm for basic 2 drawers element
+ 320 mm for each added element



cassettiere a terra e cassettiere sospese
con cassetti legno larghezza 575 mm
altezza 365 mm per modulo base a 2 cassetti
+ 320 mm per ogni modulo aggiuntivo

freestanding and hanging chest of drawers
with wooden drawers width 575 mm
height 365 mm for basic 2 drawers element
+ 320 mm for each added element



cassettiere a terra e cassettiere sospese
con cassetti legno larghezza 695 mm
altezza 365 mm per modulo base a 2 cassetti
+ 320 mm per ogni modulo aggiuntivo

freestanding and hanging chest of drawers
with wooden drawers width 695 mm
height 365 mm for basic 2 drawers element
+ 320 mm for each added element



cassettiere a terra e cassettiere sospese
con cassetti legno o vetro larghezza 935 mm
altezza 365 mm per modulo base a 2 cassetti
+ 320 mm per ogni modulo aggiuntivo

freestanding and hanging chest of drawers
with wooden or glass drawers width 935 mm
height 365 mm for basic 2 drawers element
+ 320 mm for each added element



ATTREZZATURE INTERNE / INSIDE EQUIPMENT

serie standard armadi e cabine armadio / standard set for wardrobe and walk-in-closet

Cassettiere / Chest of drawers

cassettiere a terra larghezza 1175 mm
con 2 serie cassetti legno larghezza 575 mm
altezza 365 mm per modulo base a 2 cassetti
+ 320 mm per ogni modulo aggiuntivo

freestanding chest of drawers width 1175 mm
with 2 sets of wooden drawers width 575 mm
height 365 mm for basic 2 drawers element
+ 320 mm for each added element



cassettiere a terra larghezza 1175 mm
con 1 serie cassetti legno larghezza 695 mm
altezza 365 mm per modulo base a 2 cassetti
+ 320 mm per ogni modulo aggiuntivo

freestanding chest of drawers width 1175 mm
with 1 set of wooden drawers width 695 mm
height 365 mm for basic 2 drawers element
+ 320 mm for each added element



cassettiere a terra larghezza 1415 mm
con 2 serie cassetti legno larghezza 695 mm
altezza 365 mm per modulo base a 2 cassetti
+ 320 mm per ogni modulo aggiuntivo

freestanding chest of drawers width 1415 mm
with 2 sets of wooden drawers width 695 mm
height 365 mm for basic 2 drawers element
+ 320 mm for each added element



cassettiere a terra larghezza 1415 mm
con 1 serie cassetti legno larghezza 935 mm
altezza 365 mm per modulo base a 2 cassetti
+ 320 mm per ogni modulo aggiuntivo

freestanding chest of drawers width 1415 mm
with 1 set of wooden drawers width 935 mm
height 365 mm for basic 2 drawers element
+ 320 mm for each added element

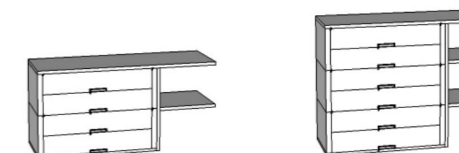

ATTREZZATURE INTERNE / INSIDE EQUIPMENT

serie standard armadi e cabine armadio / standard set for wardrobe and walk-in-closet

Elementi metallici / Metal elements

vassoio sospeso estraibile in metallo
verniciato color canna di fucile
larghezza 935 mm

hanging extractable tray in metal
lacquered canna di fucile color
width 935 mm

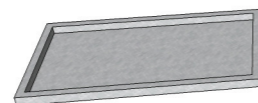

vassoio sospeso estraibile in metallo
completo di griglia divisoria
verniciato color canna di fucile
larghezza 935 mm

hanging extractable tray in metal
with partition element
lacquered canna di fucile color
width 935 mm

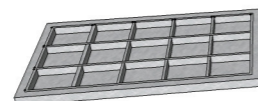

porta pantaloni sospeso estraibile
verniciato color canna di fucile
in metallo larghezza 935 mm

hanging extractable trousers hanger
lacquered canna di fucile color
in metal width 935 mm

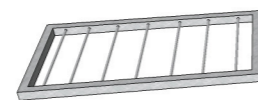

porta sacche sospeso estraibile
verniciato color canna di fucile
in metallo larghezza 935 mm

hanging extractable laundry bags
lacquered canna di fucile color
in metal width 935 mm

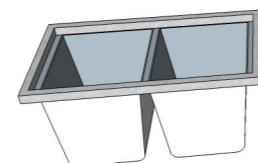

ATTREZZATURE INTERNE / INSIDE EQUIPMENT

serie standard armadi e cabine armadio / standard set for wardrobe and walk-in-closet

Attrezzature standard / Standard equipment

elemento portacamice larghezza 935 mm
con divisorio laccato canna di fucile
da utilizzarsi in appoggio su ripiani o cassettiere

shirts storage width 935 mm
with divider lacquered canna di fucile colour
to be used on top of shelf or chest of drawers

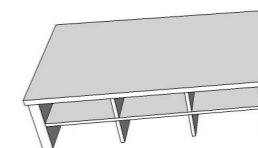

elemento portaborse larghezza 935 mm
con divisorio laccato canna di fucile
da utilizzarsi in appoggio su ripiani o cassettiere

bags storage width 935 mm
with divider lacquered canna di fucile colour
to be used on top of shelf or chest of drawers

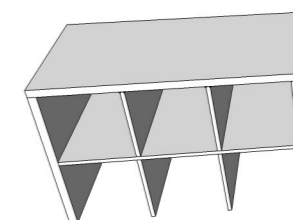

elemento porta occhiali larghezza 935 mm
con pannello laccato canna di fucile
da utilizzarsi in appoggio su ripiani o cassettiere
generalmente abbinato a porta orologi

glass storage width 935 mm
with panel lacquered canna di fucile colour
to be used on top of shelf or chest of drawers
usually in combination with watch winder

elemento porta orologi larghezza 935 mm
con pannello laccato canna di fucile
da utilizzarsi in appoggio su ripiani o cassettiere
generalmente abbinato a porta occhiali

watch winder width 935 mm
with panel lacquered canna di fucile colour
to be used on top of shelf or chest of drawers
usually in combination with glass storage

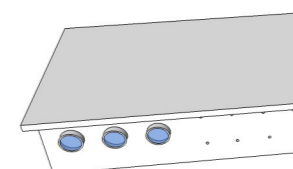

ATTREZZATURE INTERNE / INSIDE EQUIPMENT

serie standard armadi e cabine armadio / standard set for wardrobe and walk-in-closet

Attrezzature standard / Standard equipment

ripiano legno spessore 25 mm
l. 455 / 575 / 695 / 935 / 1175 / 1415 mm
ripiani speciali per angolari e terminali

wooden shelf thickness 25 mm
l. 455 / 575 / 695 / 935 / 1175 / 1415 mm
special shelves for terminal and corner

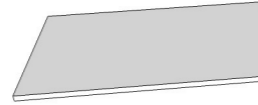

ripiano vetro extra chiaro spessore 10 mm
l. 455 / 575 / 695 / 935 mm

glass shelf extra light thickness 10 mm
l. 455 / 575 / 695 / 935 mm

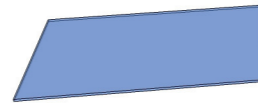

ripiano telaio in alluminio color canna di fucile
piano in vetro extra chiaro
l. 935 mm

shelf with aluminium frame canna di fucile
glass extra light plane
l. 935 mm

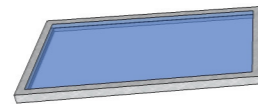

ripiano porta scarpe inclinato spessore 25 mm
profili in alluminio color canna di fucile
l. 935 mm

inclined shoes shelf thickness 25 mm
with aluminium profiles canna di fucile
l. 935 mm



ATTREZZATURE INTERNE / INSIDE EQUIPMENT

serie standard armadi e cabine armadio / standard set for wardrobe and walk-in-closet

Attrezzature standard / Standard equipment

tubo appendiabiti metallico color canna di fucile
l. 455 / 575 / 695 / 935 / 1175 / 1415 mm
tubi speciali per angolari e terminali

metallic hanging rail canna di fucile color
l. 455 / 575 / 695 / 935 / 1175 / 1415 mm
special rails for terminal and corner



servetto color marrone scuro
l. 695 / 935 mm

pull down hanging bar dark brown color
l. 695 / 935 mm



specchio applicato
l. 360 mm - h. 1700 mm
sono possibili specchi su misura

fixed mirror
l. 360 mm - h. 1700 mm
customized mirror are possible

specchio apribile
l. 360 mm - h. 1800 mm

turning mirror
l. 360 mm - h. 1800 mm

FINITURE ATTREZZATURA INTERNA / INSIDE EQUIPMENT FINISHINGS

armadio / wardrobe

Attrezzatura interna / Inside equipment

1 - laccato ghiaia opaco
mat ghiaia lacquered

2 - rovere tinto tabacco
oak painted rovere tabacco



Finitura parti metalliche / Metal equipment finishing

1 - laccato canna di fucile opaco
mat canna di fucile lacquered



WOOD

anta tutte le notti / wardrobe door

Aperture
battente
cassetti

Opening
leaf door
drawers

Finitura anta
impiallacciatura rovere (vena orizzontale)

Door finishing
oak veneer (horizontal grain)

Finitura maniglia
maniglia scavata
- massello rovere in tinta
- massello laccato colore

Handle finishings
drilled handle
- massive oak painted
- massive wood lacquered

Sezione anta / Door section

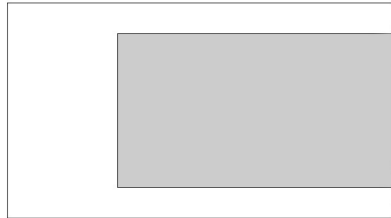

battente / leaf



48



60

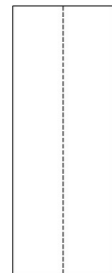

48 + 48

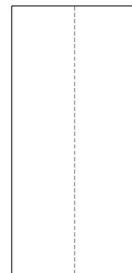

60 + 60



BASIC

anta tutte le notti / wardrobe door

Aperture

battente
scorrevole
cassetti

Opening

leaf door
sliding door
drawers

Finitura anta

laccato opaco colore
laccato lucido colore

Door finishing

mat lacquered colours
glossy lacquered colours

Finitura maniglia

maniglia scavata
- massello rovere in tinta
- massello laccato colore

Handle finishings

drilled handle
- massive oak painted
- massive wood lacquered

Sezione anta / Door section

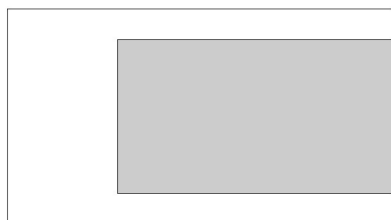

battente / leaf

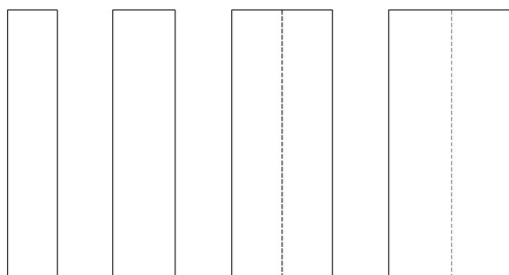

48

60

48 + 48

60 + 60

scorrevole / sliding

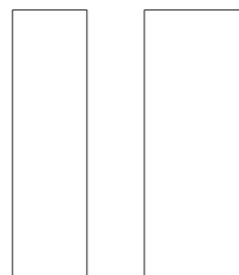

72

96

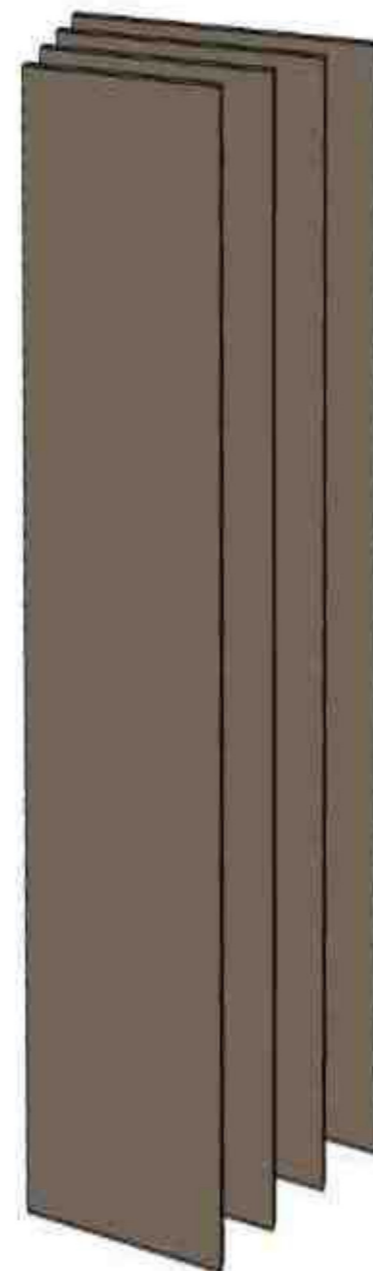

ASTOR

anta tutte le notti / wardrobe door

Aperture
battente

Opening
leaf door

Finitura anta
rovere laccato opaco colori (vena orizzontale)

Door finishing
oak mat lacquered colours (horizontal grain)

Finitura maniglia
maniglia scavata
- massello rovere laccato
- massello laccato colore

Handle finishings
drilled handle
- massive oak lacquered
- massive wood lacquered

Sezione anta / Door section

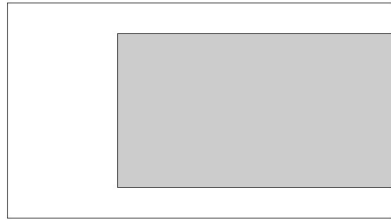

battente / leaf



48



60

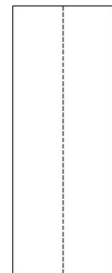

48 + 48

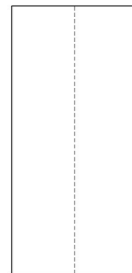

60 + 60



SKIN

anta tutte le notti / wardrobe door

Aperture

battente
scorrevole
complanare
cassetti

Opening

leaf door
sliding door
coplanar door
drawers

Finitura anta

rivestita cuoio (solo frontale)
rivestita pelle (frontale e bordi)
rivestita ecopelle (frontali e bordi)

Door finishing

covered in hide (front)
covered in leather (front & side)
covered in ecoleather (front & side)

Finitura maniglia

maniglia incassata metallica
- cromo opaco
- bianco
- canna di fucile

Handle finishings

recessed metallic handle
- chromed mat
- white mat lacquered
- canna di fucile mat lacquered

Sezione anta / Door section

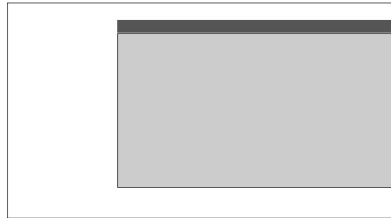

rivestita cuoio
hide covered

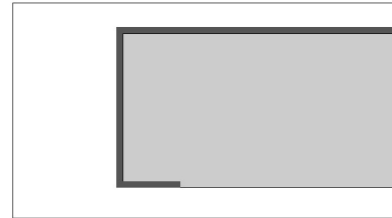

rivestita pelle / ecopelle
leather / ecoleather covered

battente / leaf

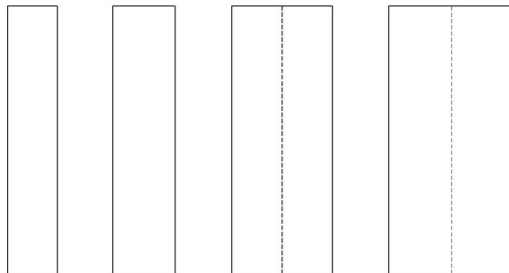

48

60

48 + 48

60 + 60

scorrevole - complanare* / sliding - coplanar*

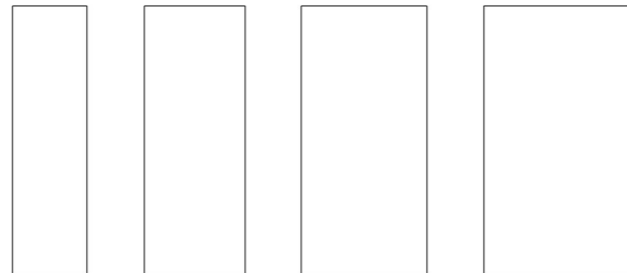

72

96

120

144*

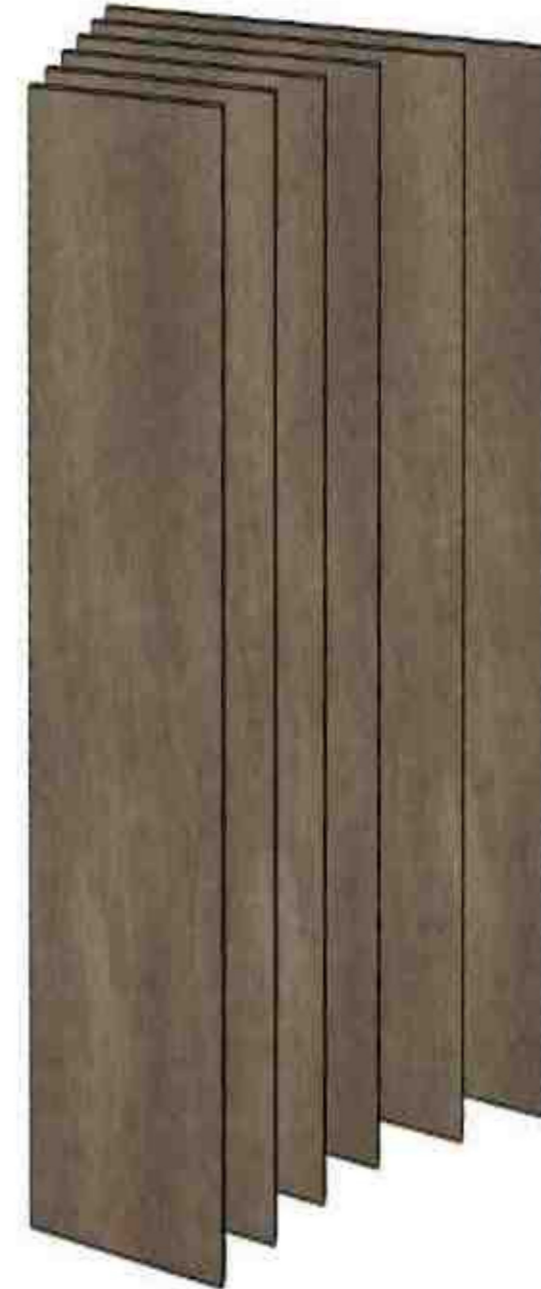

BETA

anta tutte le notti / wardrobe door

Aperture

battente
scorrevole

Opening

leaf door
sliding door

Finitura anta

vetro trasparente extrachiario
vetro bronzato riflettente
vetro fumè

Door finishing

transparent extralight glass
bronzed reflecting glass
fumè glass

Finitura profilo e maniglia

alluminio verniciato opaco canna di fucile

Profile and handle finishing

aluminium mat painted canna di fucile

Sezione anta / Door section

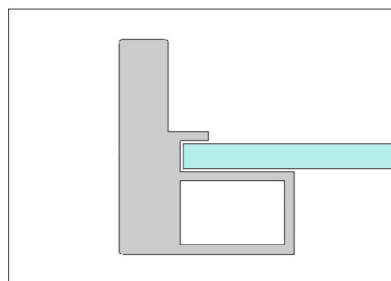

battente / leaf



48

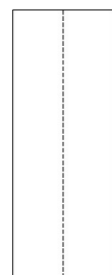

48 + 48

scorrevole / sliding



72



96

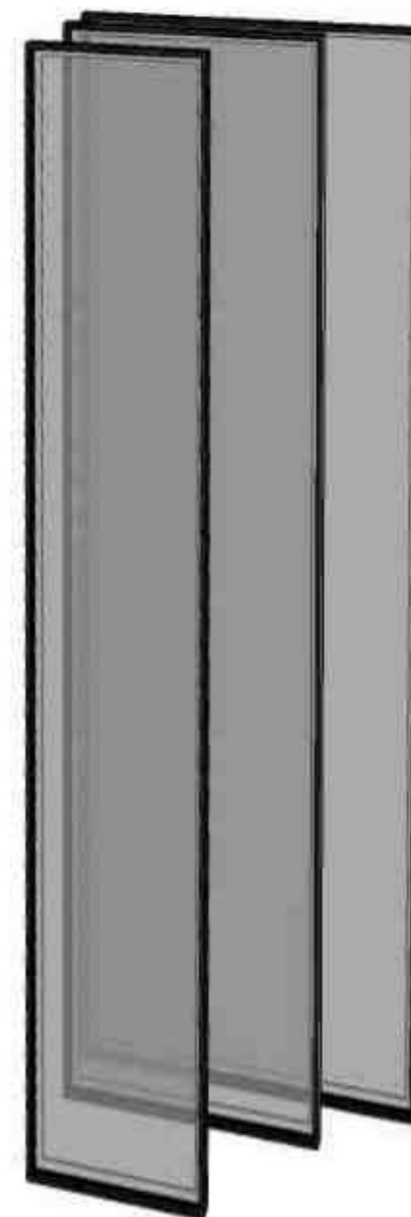

FUTURA

anta tutte le notti / wardrobe door

Apertura

battente
scorrevole

Opening

leaf door
sliding door

Finitura anta

laccato opaco colore
laccato lucido colore

Door finishing

mat lacquered colours
glossy lacquered colours

Finitura cornice

massello rovere tinto colore
massello laccato canna di fucile opaco
massello laccato alluminio opaco
massello laccato colore opaco

Frame finishings

massive oak painted
massive wood mat lacquered canna di fucile
massive wood mat lacquered aluminium
massive wood mat lacquered colours

Sezione anta / Door section

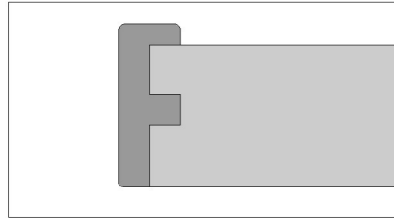

battente / leaf

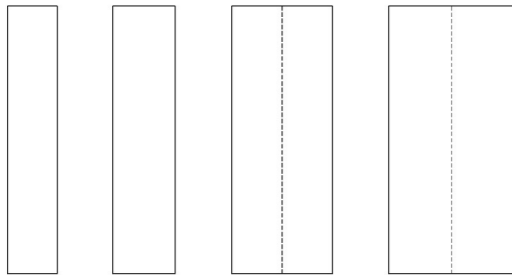

48

60

48 + 48

60 + 60

scorrevole / sliding

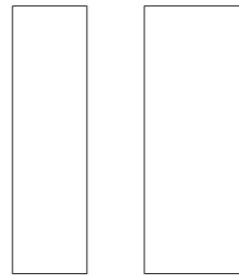

72

96

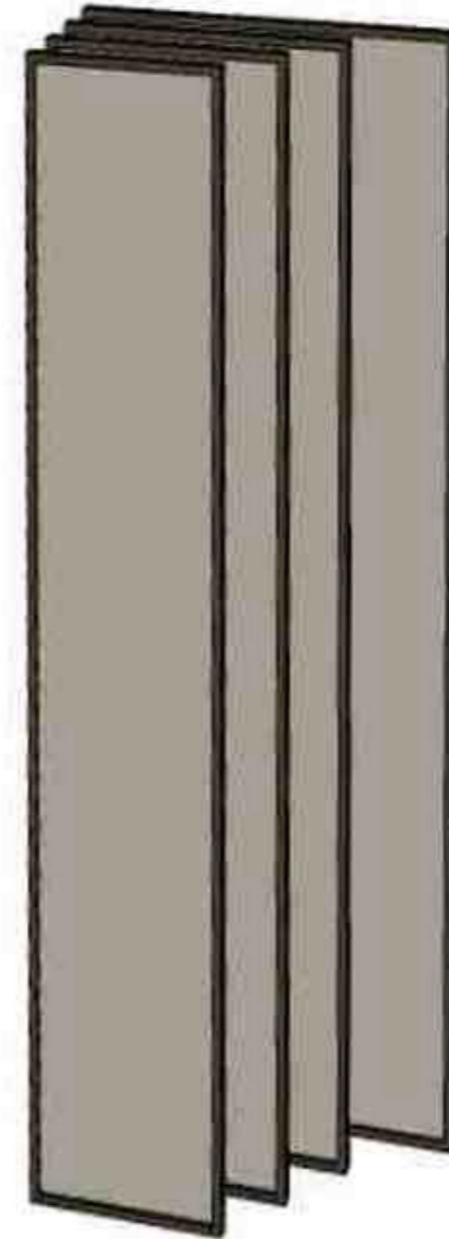

COLOR

anta tutte le notti / wardrobe door

Aperture

battente
scorrevole

Opening

leaf door
sliding door

Finitura anta

vetro lucido laccato colore
specchio
specchio bronzato
specchio fumè

Door finishing

glossy glass lacquered colours
mirror
bronzed mirror
fumè mirror

Finitura cornice

massello rovere tinto colore
massello laccato canna di fucile opaco
massello laccato alluminio opaco
massello laccato colore opaco

Frame finishings

massive oak painted
massive wood mat lacquered canna di fucile
massive wood mat lacquered aluminium
massive wood mat lacquered colours

Sezione anta / Door section

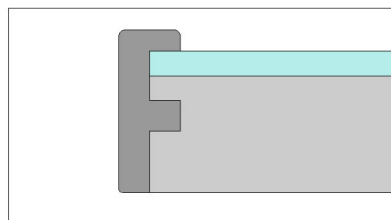

battente / leaf

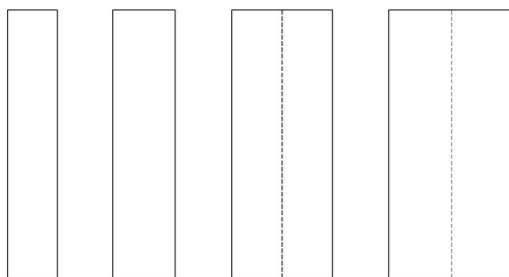

48

60

48 + 48

60 + 60

scorrevole / sliding

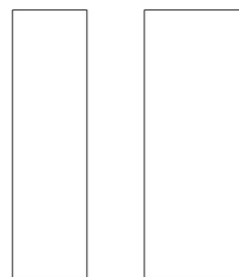

72

96

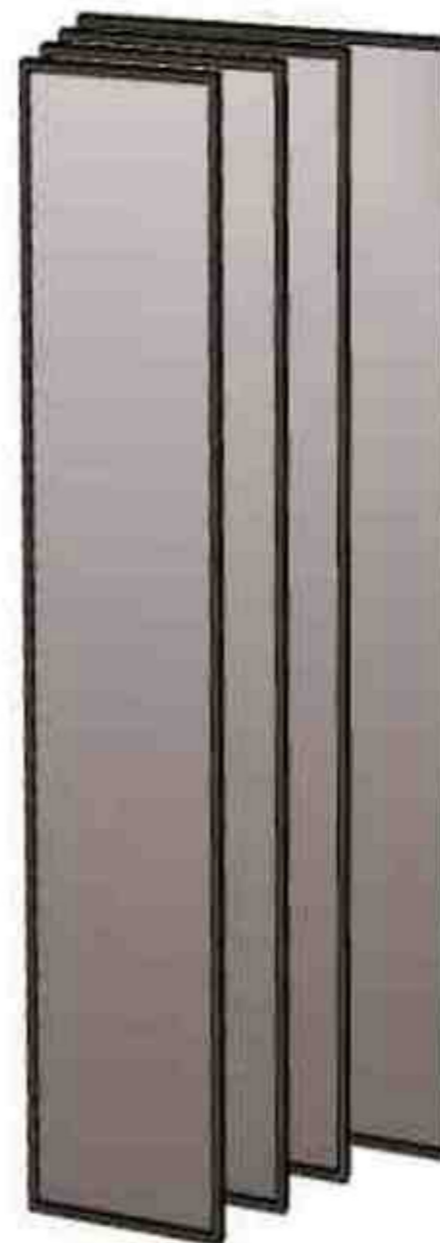

HALFA

anta tutte le notti / wardrobe door

Aperture
battente

Opening
leaf door

Finitura anta
vetro trasparente extrachiaro
vetro acidato
vetro bronzato
vetro fumè

Door finishing
trasparent extralight glass
mat glass
bronzed glass
fumè glass

Finitura profilo e maniglia
alluminio verniciato opaco
alluminio laccato opaco canna di fucile
alluminio laccato opaco colori

Profile and handle finishings
aluminium mat painted
aluminium mat lacquered canna di fucile
aluminium mat lacquered colours

Sezione anta / Door section

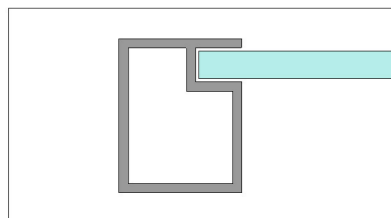

battente / leaf



48

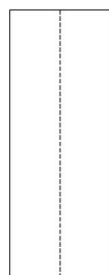

48 + 48

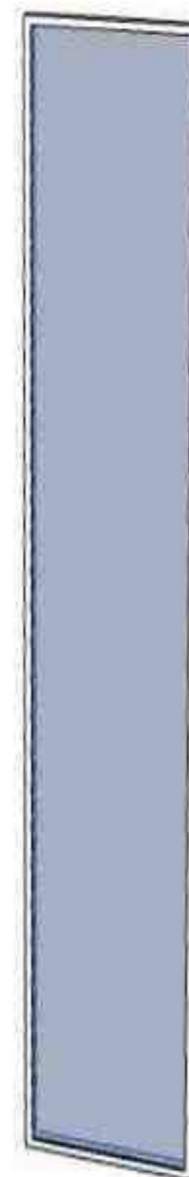

TRIS

anta tutte le notti / wardrobe door

Aperture

scorrevole
complanare

Opening

sliding door
coplanar door

Finitura anta

laccato opaco colore
laccato lucido colore
+ inserto

Door finishing

mat lacquered colour
glossy lacquered colour
+ insert

Finitura profili

laccato opaco canna di fucile
laccato opaco colore

Profile finishings

mat lacquered canna di fucile
mat lacquered colours

Sezione anta / Door section

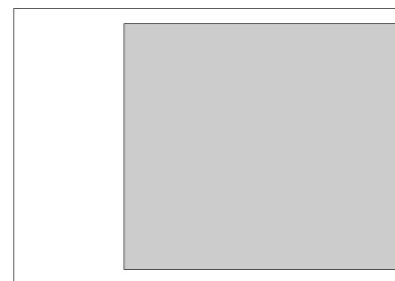
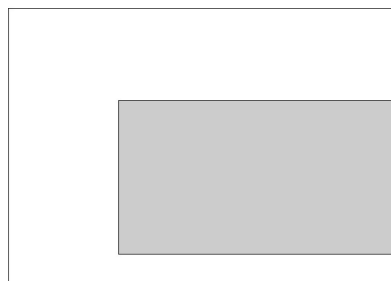

scorrevole - complanare* / sliding - coplanar*



72



96



120

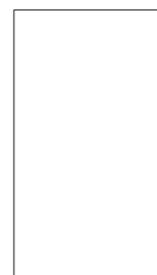

144*



LEVEL

anta tutte le notti / wardrobe door

Aperture

battente
scorrevole
complanare

Opening

leaf door
sliding door
coplanar door

Finitura anta

laccato opaco colore
laccato lucido colore

Door finishing

mat lacquered colour
glossy lacquered colour

Finitura profili e maniglia

laccato opaco colore
laccato lucido colore

Profile and handle finishings

mat lacquered colour
glossy lacquered colour

Sezione anta / Door section

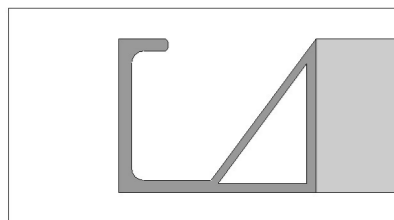

battente / leaf

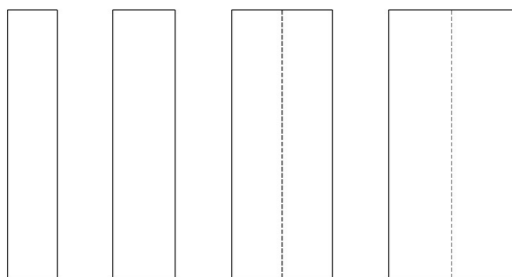

48

60

48 + 48

60 + 60

scorrevole - complanare* / sliding - coplanar*

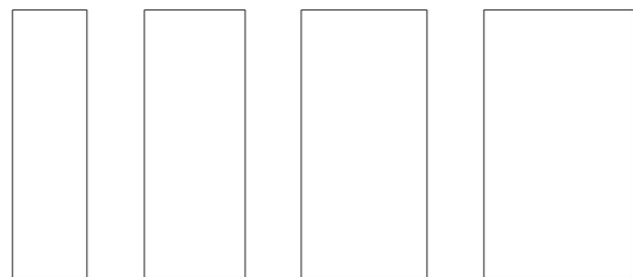

72

96

120

144*

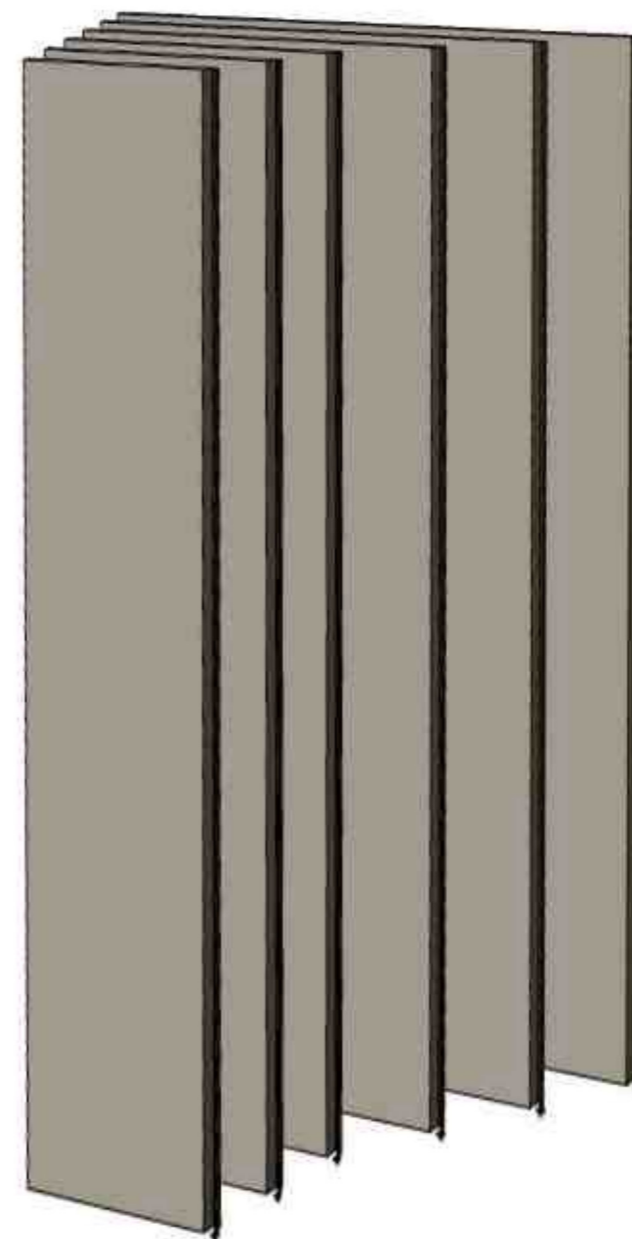

PLUMB

anta tutte le notti / wardrobe door

Aperture

battente
scorrevole

Opening

leaf door
sliding door

Finitura anta

rovere tinto colore(vena verticale)
noce canaletto (vene verticale)
eucalipto nero (vene verticale)
frassino chiaro (vene verticale)

Door finishing

oak coloured (grain vertical)
canaletto walnut (grain vertical)
black eucaliptus (grain vertical)
light ash (grain vertical)

Finitura maniglia

maniglia scavata
- massello in tinta
- massello laccato colore opaco

Handle finishing

drilled handle
- massive wood painted
- massive wood mat lacquered colours

Sezione anta / Door section

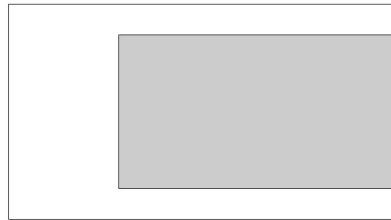

battente / leaf

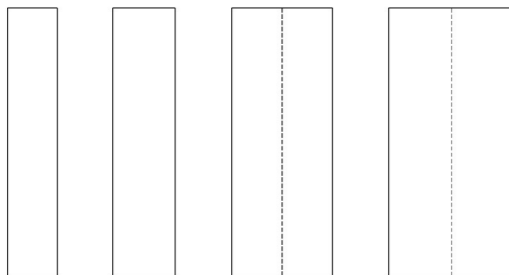

48

60

48 + 48

60 + 60

scorrevole / sliding



96



PANELLING

wall walk-in-closet / panelling



COMPONENTI STRUTTURALI / STRUCTURE COMPONENTS

cabina armadio a pannelli / wall walk-in-closet

Componenti / Components

- 1 - profilo con cremagliera fissato a muro
profile rack wall fixed
- 2 - chiusura laterale
lateral closure
- 3 - pannello schienale
back panel
- 4 - basamento intero
unified bottom shelf
- 5 - coperchio
top shelf

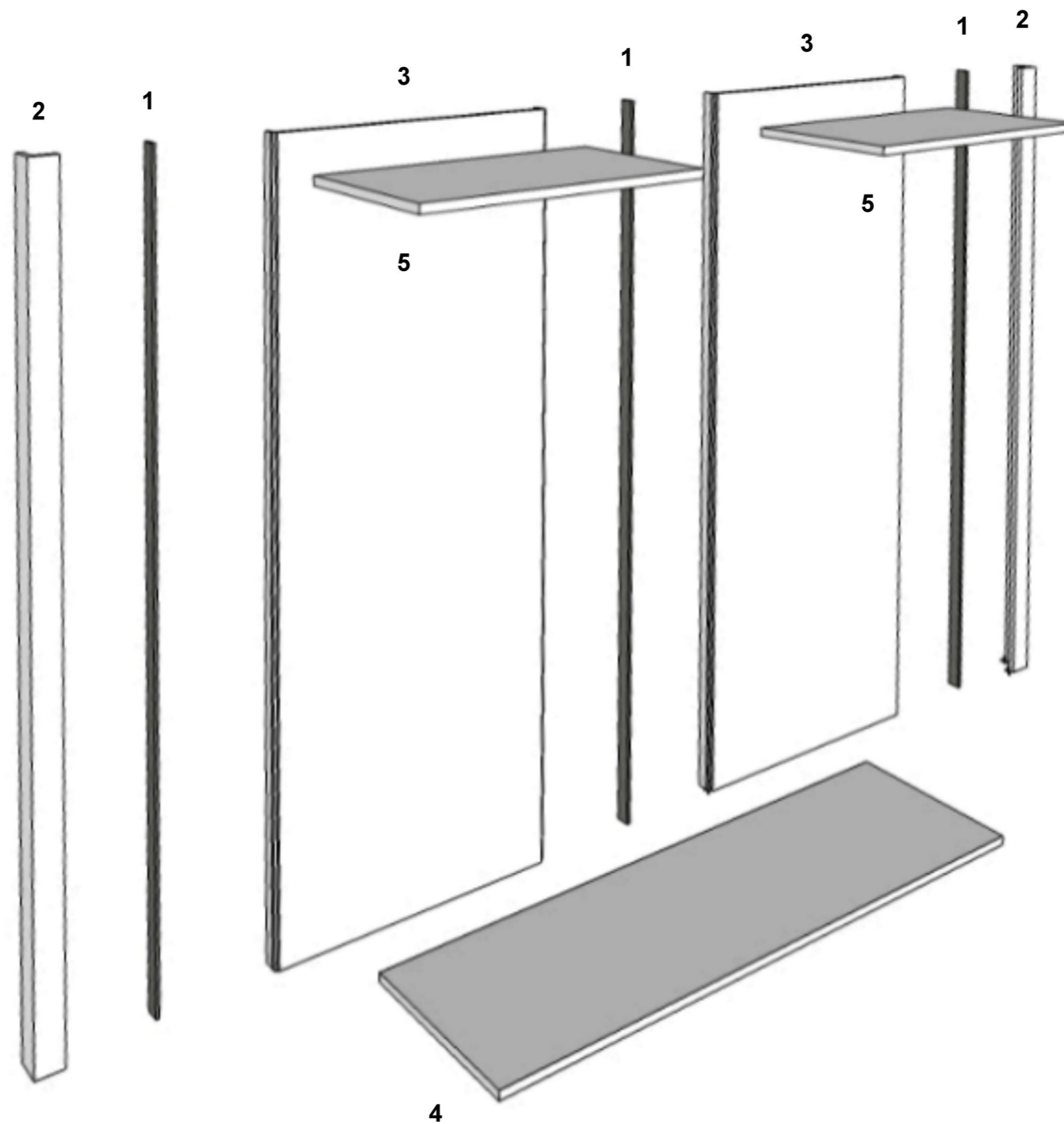

COMPONENTI STRUTTURALI / STRUCTURE COMPONENTS

cabina armadio a pannelli / wall walk-in-closet

Tipologia pannelli schienali / Back panel types

- 1** - pannello schienale spessore mm 20
lato interno rovere tinto tabacco
h. mm 2585 - 2905
l. mm 462 - 698 - 935

back panel thickness mm 20
innerside oak painted rovere tabacco
h. mm 2585 - 2905
l. mm 462 - 698 - 935

- 2** - pannello schienale spessore mm 20
lato interno laccato colore
h. mm 2585 - 2905
l. mm 462 - 698 - 935

back panel thickness mm 20
innerside matt colour lacquered
h. mm 2585 - 2905
l. mm 462 - 698 - 935

- 3** - pannello schienale spessore mm 20
lato interno rivestito pelle / ecopelle
h. mm 2585 - 2905
l. mm 462 - 698 - 935

back panel thickness mm 20
innerside leather / ecoleather covered
h. mm 2585 - 2905
l. mm 462 - 698 - 935

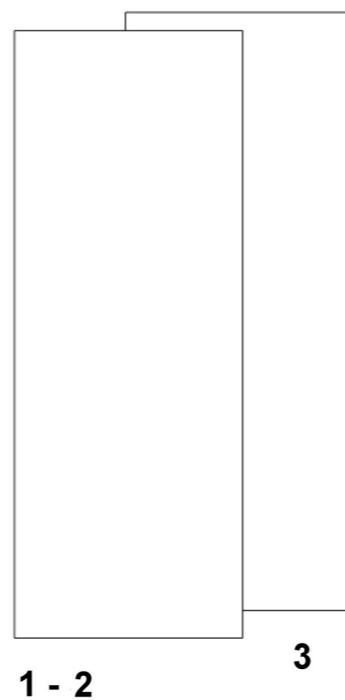

COMPONENTI STRUTTURALI / STRUCTURE COMPONENTS

cabina armadio a pannelli / wall walk-in-closet

Tipologia ripiani / Shelves types

- 1** - ripiano cabina armadio a pannelli
rovere tinto tabacco spessore mm 30
l. mm 462 - 698 - 935 - 1408

wall walk-in-closet shelf
oak painted rovere tabacco thickness mm 30
l. mm 462 - 698 - 935 - 1408



- 2** - ripiano cabina armadio a pannelli
laccato opaco colore spessore mm 30
l. mm 462 - 698 - 935 - 1408

wall walk-in-closet shelf
matt colour lacquered thickness mm 30
l. mm 462 - 698 - 935 - 1408



MODULARITA' STRUTTURA / STRUCTURE MODULARITY

cabina armadio a pannelli / wall walk-in-closet

Modularità / Modularity

1 - profilo con cremagliera 11 mm
profile rack 11 mm

2 - struttura 473 mm
(pannello 462 mm + profilo 11 mm)
structure 473 mm
(panel 462 mm + profile 11 mm)

3 - struttura 709 mm
(pannello 698 mm + profilo 11 mm)
structure 709 mm
(panel 698 mm + profile 11 mm)

4 - struttura 946 mm
(pannello 935 mm + profilo 11 mm)
structure 946 mm
(panel 935 mm + profile 11 mm)

5 - struttura 1419 mm
(pannell 462 + 935 mm + 2 profili 11 mm)
structure 473 mm
(panels 462 + 935 mm + 2 profiles 11 mm)

6 - struttura 1419 mm
(2 pannelli 698 mm + 2 profili 11 mm)
structure 709 mm
(2 panels 698 mm + 2 profiles 11 mm)

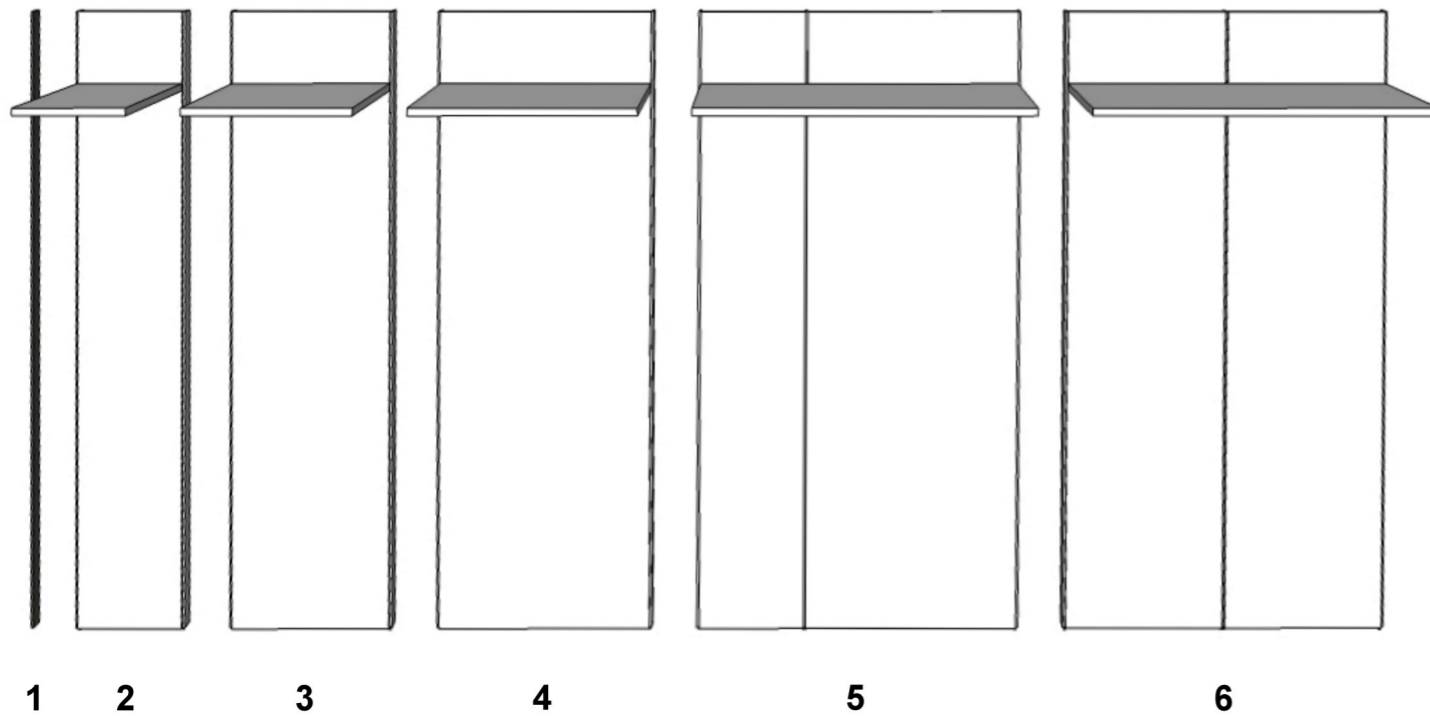

FINITURA STRUTTURA / STRUCTURE FINISHINGS

armadi e cabine armadio / wardrobe and walk-in-closet

Componenti strutturali / Structure components

1 - laccato opaco colore
matt colour lacquered

2 - rovere tinto tabacco
oak painted rovere tabacco



Attrezzatura interna/ Inside equipment

1 - laccato opaco colore
matt colour lacquered

2 - rovere tinto tabacco
oak painted rovere tabacco



ATTREZZATURE INTERNE / INSIDE EQUIPMENT

cabina armadio a pannelli / wall walk-in-closet

1 - cassetiera a terra cassetti legno
freestanding chest of drawers with
wooden drawers

2 - cassetiera sospesa cassetti legno
hanging chest of drawers with
wooden drawers

3 - cassetiera su ruote cassetti legno
chest of drawers on wheels with
wooden drawers

4 - cassetiera su ruote cassetti vetro
chest of drawers on wheels with
glass drawers

5 - ripiano legno
wooden shelf

6 - tubo appendiabiti
hanging rail

7 - servetto
pull down hanging bar

8 - box pensile
hanging box

9 - box con cassetini
box with little drawers

10 - porta camice
shirt storage

11 - porta pantaloni estraibile
pull out trousers hanger

12 - porta stivali
boots hanger

13 - basamento intero
(fino alla misura 2850 mm)
unified bottom shelf
(up to 2850 mm)

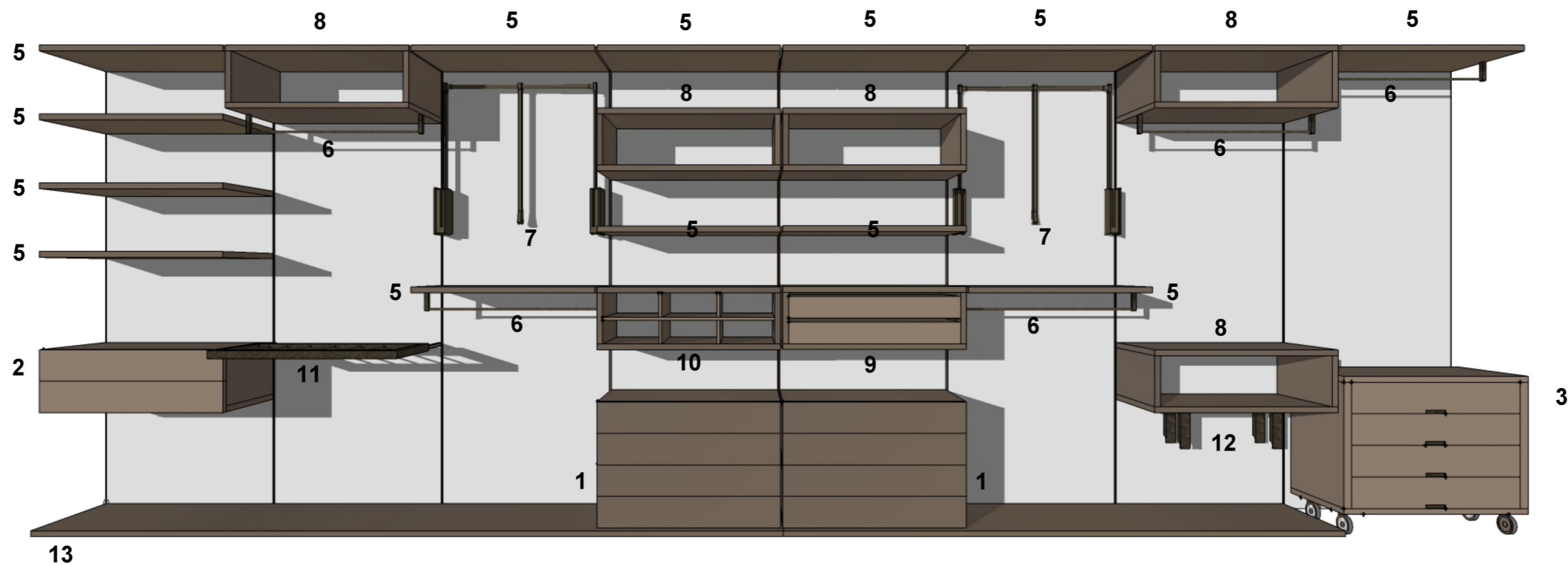

ATTREZZATURE INTERNE / INSIDE EQUIPMENT

cabina armadio a pannelli / wall walk-in-closet

Cassettiere / Chest of drawers

cassettiera a terra a cassetti legno
larghezza 462 - 698 - 935 mm
altezza 380 mm per elemento a 2 cassetti

freestanding wooden chest of drawers
width 462 - 698 - 935 mm
height 380 mm for 2 drawers element



cassettiera a terra a cassetti legno
larghezza 462 - 698 - 935 mm
altezza 700 mm per elemento a 4 cassetti

freestanding wooden chest of drawers
width 462 - 698 - 935 mm
height 700 mm for 4 drawers element

cassettiera sospesa a cassetti legno
larghezza 462 - 698 - 935 mm
altezza 380 mm per elemento a 2 cassetti

hanging wooden chest of drawers
width 462 - 698 - 935 mm
height 380 mm for 2 drawers element

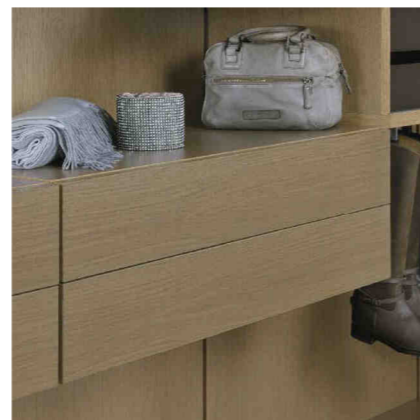

cassettiera su ruote a cassetti legno o vetro
larghezza 935 mm
altezza 830 mm per elemento a 4 cassetti

wooden or glass chest of drawers on wheels
width 935 mm
height 830 mm for 4 drawers element



ATTREZZATURE INTERNE / INSIDE EQUIPMENT

cabina armadio a pannelli / wall walk-in-closet

Attrezzatura / Equipment

ripiano legno spessore 30 mm
l. 462 / 698 / 935 mm
ripiani speciali per angolari e strutture su misura

wooden shelf thickness 30 mm
l. 462 / 698 / 935 mm
special shelves for corner and customized unit

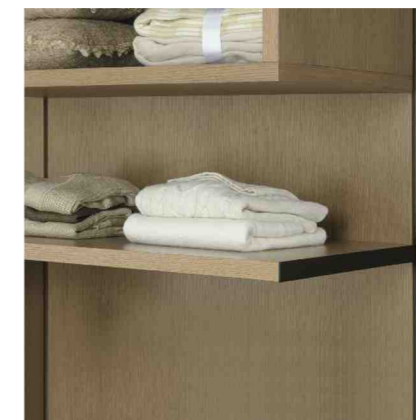

tubo appendiabiti metallico color canna di fucile
l. 462 / 698 / 935 mm
tubi speciali per angoli e strutture su misura

metallic hanging rail canna di fucile color
l. 462 / 698 / 935 mm
special rails for corner and customized unit

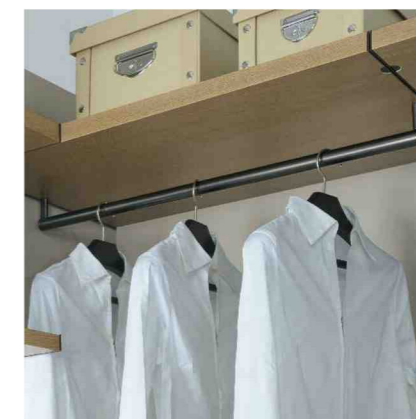

servetto color marrone scuro
l. 698 / 935 mm

pull down hanging bar dark brown color
l. 698 / 935 mm



ATTREZZATURE INTERNE / INSIDE EQUIPMENT

cabina armadio a pannelli / wall walk-in-closet

Attrezzatura / Equipment

elemento box larghezza 935 mm
struttura spessore 30 mm

storage box width 935 mm
structure thickness 30 mm

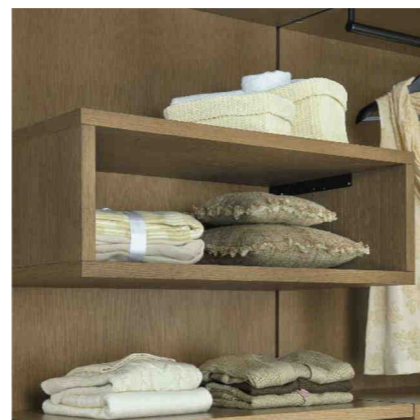

elemento portacamice larghezza 935 mm
con divisorio laccato canna di fucile
struttura spessore 30 mm

shirt storage width 935 mm
with divider lacquered canna di fucile colour
structure thickness 30 mm

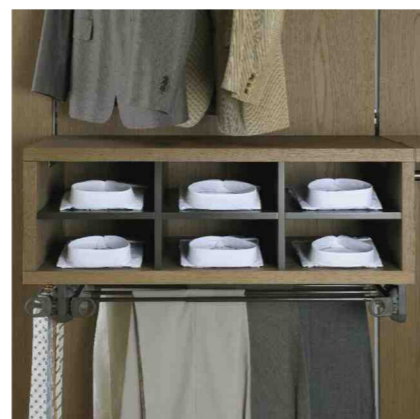

elemento portagioie larghezza 935 mm
con 2 cassetti laccati
struttura spessore 30 mm

jewellery box width 935 mm
with 2 lacquered drawers
structure thickness 30 mm

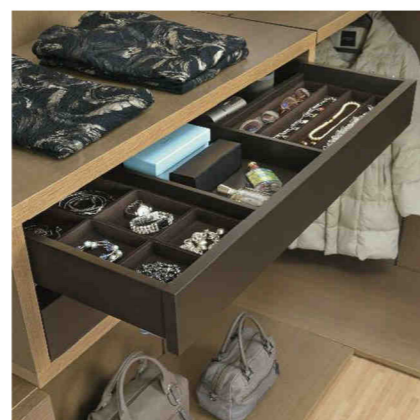

ATTREZZATURE INTERNE / INSIDE EQUIPMENT

cabina armadio a pannelli / wall walk-in-closet

Attrezzatura / Equipment

porta pantaloni sospeso estraibile
verniciato color canna di fucile
in metallo larghezza 935 mm

hanging extractable trousers hanger
lacquered canna di fucile color
in metal width 935 mm

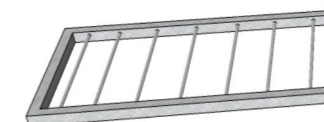

porta stivali
con aggancio magnetico

boots tray
with magnetic holder



specchio applicato
dimensioni su misura

fixed mirror
customized sizes

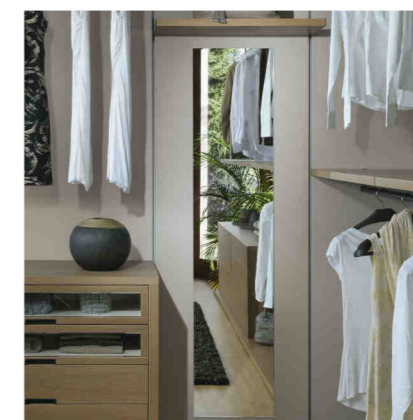

FINITURE PER ESTERNI / OUTSIDE FINISHINGS

spalle esterne e ante / external sides and doors

Essenze / Woods

Rovere / Oak

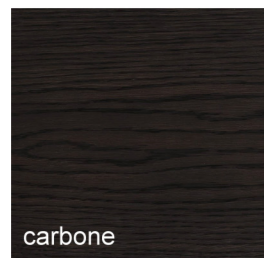

carbone

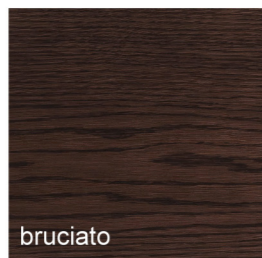

bruciato

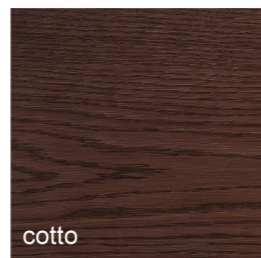

cotto

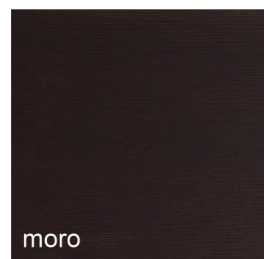

moro

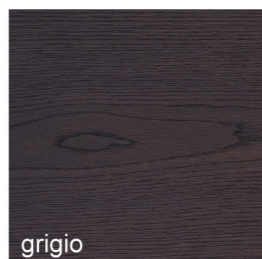

grigio



cenere

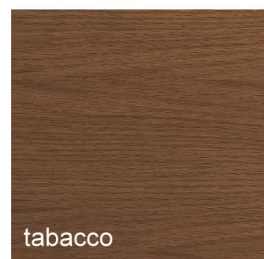

tabacco



miele



sbiancato

Altri legni / Others woods

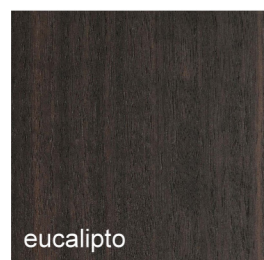

eucalipto

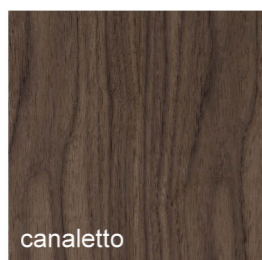

canaletto



frassino

FINITURE PER ESTERNI / OUTSIDE FINISHINGS

spalle esterne e ante / external sides and doors

Rovere laccato a poro aperto / Oak colour lacquered

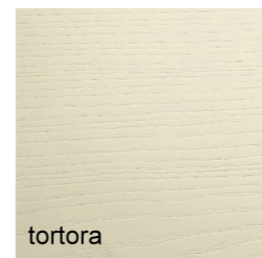

tortora



latte



caffè

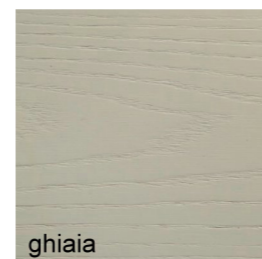

ghiaia



mastice

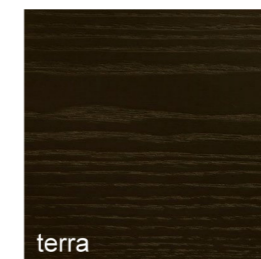

terra



testa di moro



bianco



grafite

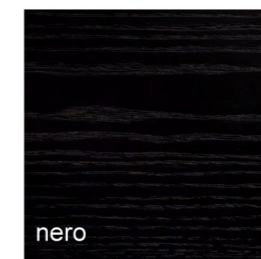

nero



rosso rubino

FINITURE PER ESTERNI / OUTSIDE FINISHINGS

spalle esterne e ante / external sides and doors

Laccature opache / Matt lacquerings



tortora

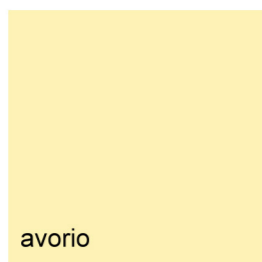

avorio



giallo senape



giallo ginestra



pesca



mandarino



arancio



ruggine



rosso mattone



rosso rubino



viola

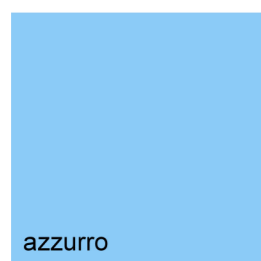

azzurro



ottanio



blu cina

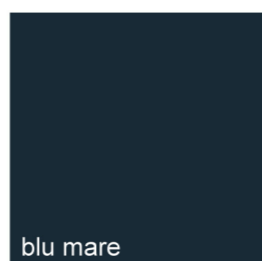

blu mare

FINITURE PER ESTERNI / OUTSIDE FINISHINGS

spalle esterne e ante / external sides and doors

Laccature opache / Matt lacquerings



verde pistacchio



verde acqua



ghiaia



mastice



terra



canna di fucile



sabbia



cognac



cioccolato



testa di moro

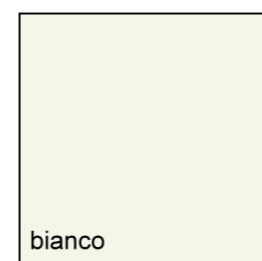

bianco



grigio



grafite



nero

FINITURE PER ESTERNI / OUTSIDE FINISHINGS

spalle esterne e ante / external sides and doors

Vetro trasparente / Transparent glass

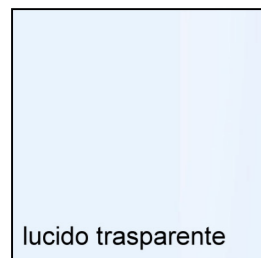

Specchio / Mirror

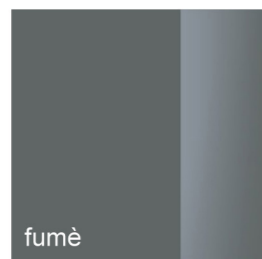

Vetro riflettente / Reflecting glass

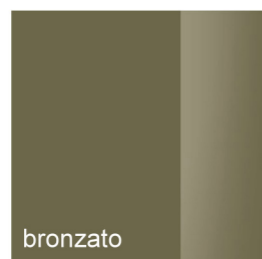
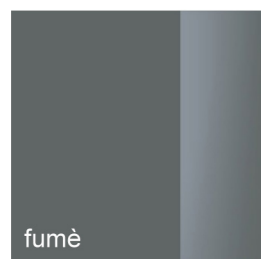

FINITURE PER ESTERNI / OUTSIDE FINISHINGS

spalle esterne e ante / external sides and doors

Vetri laccati / Lacquered glass

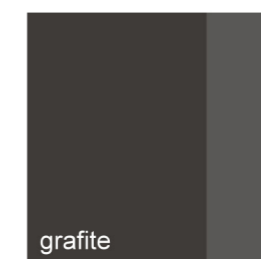
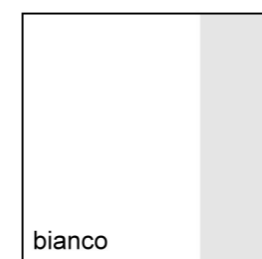
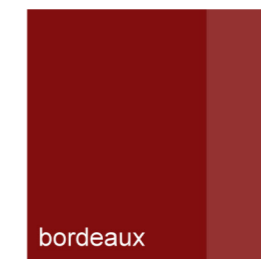
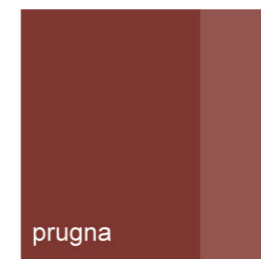
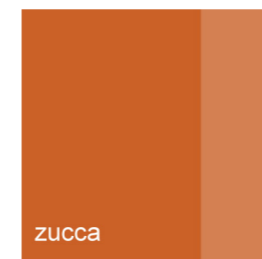
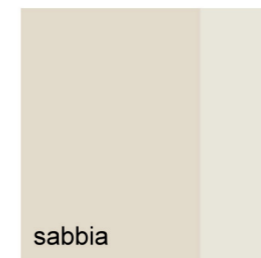

FINITURE PER ESTERNI / OUTSIDE FINISHINGS

spalle esterne e ante / external sides and doors

Pelle / Leather



ghiaccio



vaniglia

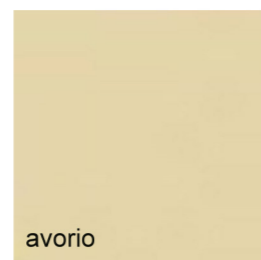

avorio



ghiaia

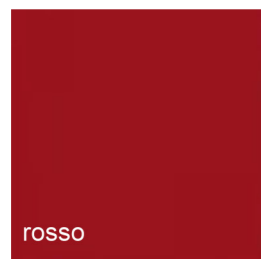

rosso



tan



rosso bulgare



ottanio

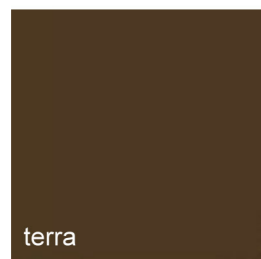

terra

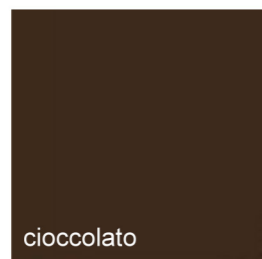

cioccolato

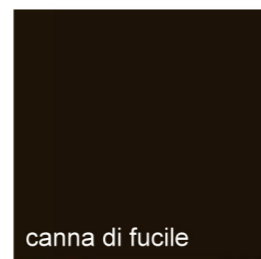

canna di fucile



testa di moro



bianco



grigio cenere



grigio scuro

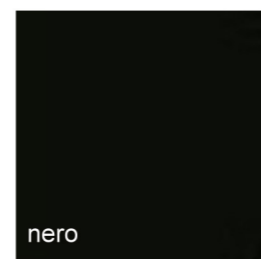

nero

FINITURE PER ESTERNI / OUTSIDE FINISHINGS

spalle esterne e ante / external sides and doors

Ecopelle / Ecoleather



beige



light camel

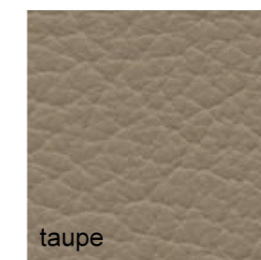

taupe



elephant



tabac



brown



bordeaux

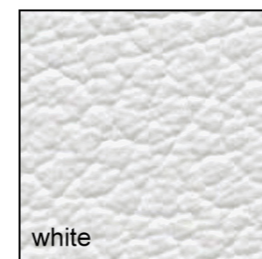

white



light grey



grey

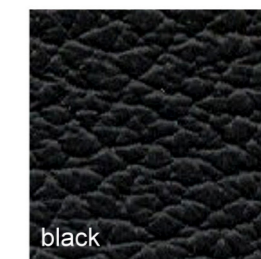

black

FINITURE PER ESTERNI / OUTSIDE FINISHINGS

spalle esterne e ante / external sides and doors

Cuoio / Hide



ghiaccio



vaniglia

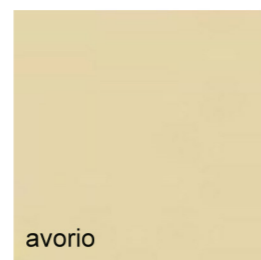

avorio

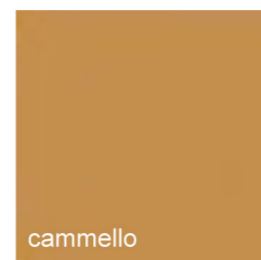

cammello

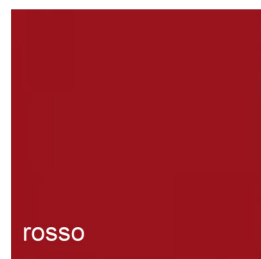

rosso



tan



rosso bulgaro

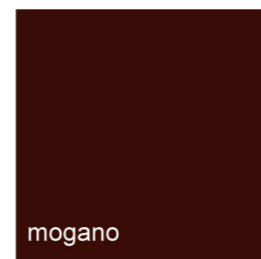

mogano



terra

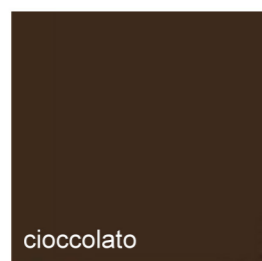

cioccolato

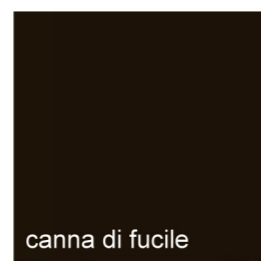

canna di fucile



testa di moro



bianco



grigio cenere



grigio scuro

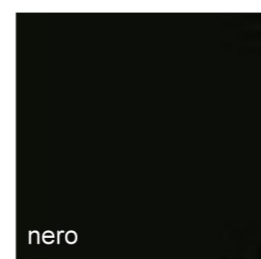

nero

FINITURE PER ESTERNI / OUTSIDE FINISHINGS

spalle esterne e ante / external sides and doors

Cuoio rigenerato / Rogenerated hide



vanilla

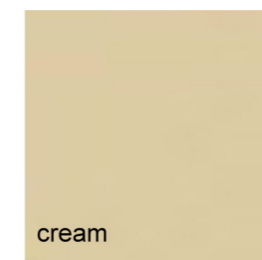

cream

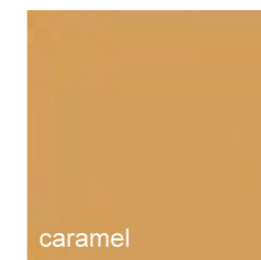

caramel

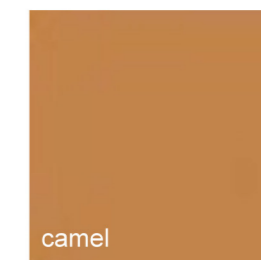

camel



red



red bulgaro



havana

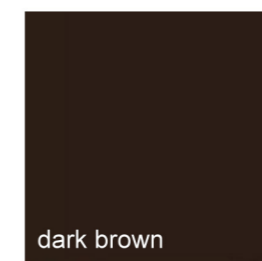

dark brown



white



ash grey



dark grey

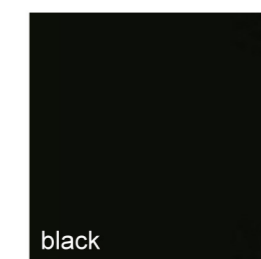

black

FINITURE PER ESTERNI / OUTSIDE FINISHINGS

spalle esterne e ante / external sides and doors

Econabuk / Econabuk

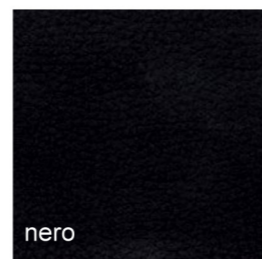
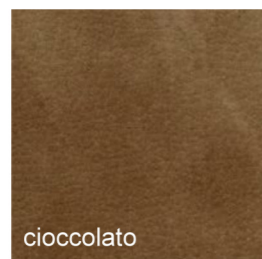
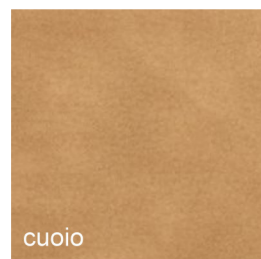

Line Gian.Ser. sas

via S. Ambrogio, 1
22066 Mariano Comense

Como - Italy

www.linegianser.com

tel. +39 031745554

fax. +39 031743112

info@linegianser.com